

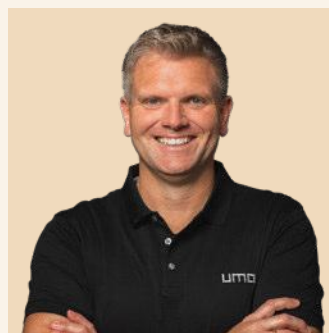

NA
20

NATURALS
2025 2025



Es liegt in der Natur der Sache, dass der Mensch sich gerne sicher und geborgen fühlt. Aus Sicht der Verbraucher werden somit die Themen Nachhaltigkeit und Umweltschutz immer weiter in den Fokus der Kaufentscheidung gerückt. Neben den Umwelt- und Sozialstandards interessiert sich der Verbraucher für die gesamte Wertschöpfungskette des Produktes und das verantwortungsvolle Handeln der Unternehmen. Vielleicht ist es gerade für die haptische Werbewelt entscheidend, dass ein tatsächlich in der Hand liegendes Produkt Vertrauen und Nachhaltigkeit transportiert.

Die uma Schreibgeräte Ullmann GmbH hat sich der Nachhaltigkeit buchstäblich verschrieben und es ist uns ein persönliches Anliegen für Mensch und Umwelt verantwortlich und pflichtbewusst zu handeln. Aus einem erfolgreichen, umweltbewussten Management entstehen so Produkte, die das Prädikat „Nachhaltig“ mehr als verdient haben.

Mit dem uma RECYCLED PET PEN zeigen wir, dass man aus PET-Material einen sehr ansprechenden und sehr gut schreibenden recycelten Werbeträger erzeugen kann. Die uma RECYCLED PET PEN Schreibgeräte-Serie ist bereits Gewinner des Sustainability Awards, wurde nominiert zum Deutschen Nachhaltigkeitspreis und zuletzt 2021 ausgezeichnet mit dem German Innovation Award in Gold. Der RECYCLED PET PEN PRO ocean ergänzt das Portfolio nachhaltig. Design und Idee wurde mit dem Special German Design Award 2024 ausgezeichnet und bestätigt unsere Kooperation und Zusammenarbeit mit der Plastic Bank® eindrucksvoll. 2025 wurde der uma RECYCLED PET PEN ALUMA ebenfalls mit dem German Design Award für nachhaltiges Design gewürdigt. Für uns sind das eindeutige Belege, dass eine Investition in Forschung und Entwicklung einen Mehrwert für unseren Planeten erzielen kann.

Alle uma Schreibgeräte stehen für langlebiges und erfolgreiches Werben. Deshalb ist ein Nachfüllen der Minen in allen Schreibgeräten selbstverständlich, sowie die Tatsache, dass alle eingesetzten Materialien recycelt werden können und erneuten Einsatz in unseren RECY-Modellen finden.

Mit den FSC®- und PEFC-zertifizierten uma Holzschreibgeräten tragen wir dazu bei, dass nicht nur der Schwarzwald auch in Zukunft für die Nachwelt positiv erhalten bleibt.

Mit den antimikrobiellen Schreibgeräten kombinieren wir Nachhaltigkeit und Hygiene. Damit beweisen wir nicht nur Innovationskraft sondern lösungsorientierte Ideen zum Schutz von Natur und Mensch.

Alle Modelle der umaNATURALS-Serie werden klimaoptimiert produziert und am Standort in Fischerbach auf einer der weltweit modernsten Veredelungsstraßen für Werbeschreibgeräte auch klimaoptimiert veredelt.

Der uma Hauptstandort Fischerbach arbeitet seit 2019 ClimatePartner-zertifiziert durch Kompensationszahlung von nicht vermeidbarem CO₂-Ausstoß. Mit den DIN EN ISO 9001:2015 und DIN EN ISO 14001:2015 Zertifizierungen wurde uns ein durch den TÜV SÜD-geprüftes Qualitäts- und Umweltmanagementsystem bescheinigt.

Unternehmerische Gesellschaftsverantwortung vereint mit innovativen Produktideen und nachhaltigen Produktionsprozessen. Das ist die gelebte uma Philosophie für langfristiges, erfolgreiches und nachhaltiges Handeln.

Alexander Ullmann (CEO)



It is inherent to human nature that people like to feel secure and protected. From the consumer's perspective, sustainability and environmental protection are becoming increasingly important factors in purchasing decisions. In addition to environmental and social standards, consumers are also concerned with the entire value chain of a product and the responsible actions of the companies involved. Perhaps it is particularly important for the haptic advertising world that a product physically held in hand conveys trust and sustainability.

uma Schreibgeräte Ullmann GmbH is literally committed to sustainability, and it is our personal mission to act responsibly and conscientiously for both people and the environment. Through successful, environmentally conscious management, we produce products that more than deserve the label "Sustainable."

With the uma RECYCLED PET PEN, we demonstrate that it is possible to create a highly attractive and excellent writing recycled promotional item from PET material. The uma RECYCLED PET PEN series has already won the Sustainability Award, been nominated for the German Sustainability Award, and was most recently awarded the German Innovation Award in Gold in 2021. The RECYCLED PET PEN PRO ocean sustainably adds to the portfolio. Its design and concept were honoured with the Special German Design Award 2024, which highlights our cooperation and collaboration with Plastic Bank® impressively. In 2025, the uma RECYCLED PET PEN ALUMA was also honoured with the German Design Award for sustainable design. For us, these are clear indications that investing in research and development can deliver added value for our planet.

All uma writing instruments stand for long-lasting and successful advertising. Therefore, refilling the ink cartridges in all writing instruments is a given, as is the fact that all materials used can be recycled and reused in our RECY models.

With the FSC® and PEFC certified uma wooden pens, we contribute to ensuring that not only the Black Forest but also future generations benefit from its preservation.

With our antimicrobial writing instruments, we combine sustainability and hygiene. In doing so, we demonstrate not only innovation but also solution-oriented ideas for protecting both nature and people.

All models in the umaNATURALS series are produced climate optimised, and at our Fischerbach location, they are refined on one of the most modern finishing lines for promotional writing instruments worldwide, also in a climate optimised manner.

Since 2019, the uma headquarters in Fischerbach has been climate neutral, achieved through compensation payments for unavoidable CO2 emissions. With the DIN EN ISO 9001:2015 and DIN EN ISO 14001:2015 certifications, we were certified as having quality and environmental management system certified by TÜV SÜD.

Corporate social responsibility, combined with innovative product ideas and sustainable production processes, is the philosophy that uma lives by for long-term, successful, and sustainable action.

Alexander Ullmann (CEO)





Vorwort/Foreword	2 – 3
Verantwortung/Responsibility	6 – 7
Zertifizierungen/Certifications	8
Innovation/Innovation	9
Nachhaltigkeit/Sustainability	10 – 11
Nachhaltige Materialien/ Sustainable materials	12 – 13



rPET-Modelle/rPET models	14 – 45
RECYCLED PET PEN CHANGE	16 – 19
RECYCLED PET PEN FUTURE	20 – 23
RECYCLED PET PEN STEP	24 – 25
RECYCLED PET PEN PRO	26 – 33
RECYCLED PET PEN PRO F ocean	34 – 35
RECYCLED PET PEN PRO antibacterial	36 – 37
RECYCLED PET PEN PRO F TOUCH	38 – 39
RECYCLED PET PEN ALUMA	40 – 41
RECYCLED PET PEN	42 – 43
RECYCLED PET PEN switch	44 – 45



RECY-Modelle/RECY models	46 – 61
TRINITY RECY	48 – 51
YES RECY	52
HAPPY RECY	52
VITAN RECY	53
ON TOP RECY	54 – 55
PIXEL RECY	56
ICONIC RECY	56
VANE RECY	57
POP RECY	57
CHILL RECY	58 – 59
ULTIMATE RECY	60 – 61
CETA RECY	61

62 – 75	Holz-Modelle / Wooden models
64 – 65	ROOT
66 – 67	TREE
67	LEAF
68	WOODY
69	FOREST
69	BEECH
70 – 71	TREECK-SET
72 – 73	TITAN WOOD
74 – 75	ELEGANCE WOOD



76	Bio-Modelle / Bio models
79	BIO PEN



77	Karton-Modelle / Cardboard models
78 – 79	PAPER PEN



80	Metall RECY-Modelle / Metal RECY models
82 – 83	STRAIGHT GUM RECY



81	Aluminium RECY-Modelle / Aluminium RECY models
84 – 85	GROOVE RECY
86 – 87	LUMOS RECY



88-90	Zubehör / Accessoires
88 – 89	RECYCLED PET BOX
90	ETUI
91	Verpackung / Packaging







Wir übernehmen Verantwortung

Wir von uma stehen für ein verantwortliches Wirtschaften. Das bedeutet, dass bei uns Werte wie Qualität und Kundenzufriedenheit, wie auch die Einhaltung sozialer Verhaltensweisen und Aspekte der Nachhaltigkeit an oberster Stelle stehen.

Auch bei unseren Partnern legen wir höchsten Wert auf menschenwürdige und umweltverträgliche Arbeitsbedingungen, wie beispielsweise die Einhaltung von Arbeitnehmerrechten, das Verbot von Kinder- und Zwangsarbeit, sowie den verantwortungsbewussten Umgang mit der Natur und ihren Ressourcen. Für die Einhaltung dieser Ziele stehen wir mit unserem Namen.

Für unsere gesellschaftliche Verantwortung (CSR) wurden wir von EcoVadis mit der Bronzemedaille ausgezeichnet.

Eine prozesssichere und nachhaltige Arbeitsweise wurde durch die DIN EN ISO 9001:2015 und DIN EN ISO 14001:2015 Zertifizierung vom TÜV SÜD bescheinigt.

We assume responsibility

For a company focused on the future, it almost goes without saying that quality, service and, by extension, customer loyalty, should always be maintained at the highest level.

The holistic view-point of any successful company must encompass seamless observance of social modes of behaviour in the daily conduct of its business. The scope of our sense of responsibility extends to the assurance of environmentally compliant working conditions that are truly worthy of our payroll staff. That translates into things like respect for employee rights, the prohibition of child labour and forced labour, as well as a responsible attitude towards our natural world and its resources. We put our name on the line when it comes to achievement of these objectives.

EcoVadis rewarded us with a bronze medal for our corporate social responsibility (CSR).

The DIN EN ISO 9001:2015 and DIN EN ISO 14001:2015 certifications from TÜV SÜD confirm that the company's processes are reliable and sustainable.

umaSECRETS

In den umaSECRETS erfahren Sie mehr darüber, wie man bei uma Nachhaltigkeit und soziale Verantwortung nicht nur schreibt, sondern auch lebt. Fordern Sie ihre persönliche Broschüre an oder lesen Sie online im Downloadbereich auf uma-pen.com.

umaSECRETS

With our umaSECRETS you can find out how uma puts sustainability and social responsibility into practice. Order your personal brochure now, or download it online at uma-pen.com.





PEFC- und FSC®-Zertifizierung

Als Produzent aus dem Schwarzwald freut es uns, PEFC- und FSC®-zertifizierte Holzschreibgeräte garantieren zu können und somit zum Schutz von nachhaltigen Rohstoffen beizutragen. Für uns ist es eine Selbstverständlichkeit, an diesem Verfahren zur nachhaltigen Waldbewirtschaftung und zum Schutz eines wichtigen Rohstoffes teilzunehmen.

Die Zertifikate garantieren, dass Holz- und Papierprodukte aus nachhaltig bewirtschafteten Wäldern stammen. Mit einer Fläche von über 265 Millionen Hektar zertifizierter Waldfläche garantiert PEFC als größtes Waldzertifizierungssystem weltweit ausreichend Rohstoffmengen. Und rund 1,44 Millionen Hektar Wald sind in Deutschland FSC®-zertifiziert. Dank dieser Zertifizierungen übernehmen wir bei uma gesellschaftliche Verantwortung, denn wir unterstützen den verantwortungsbewussten Umgang mit Ressourcen und setzen uns somit für den aktiven Beitrag zum Erhalt der Wälder ein.

PEFC and FSC® certification

As producer in the Black Forest we are happy to present and warranty you PEFC and FSC® certified pens made of wood and that we have a share in the prevention of enduring raw materials. For uma Schreibgeräte Ullmann GmbH it is self-evident to take part in the sustainable forest cultivation and for the safety of a very important resource.

These certifications guarantee that wood and paper products come from sustainably managed forests. With over 265 million hectares (655 million acres) of certified forests, PEFC is the world's largest forest certification system and guarantees sufficient quantities of raw materials. And about 1.44 million hectares German forests are FSC® certified. Thanks to this certifications, we at uma assume social responsibility by supporting responsible use of resources and being committed to making an active contribution to preserving forests.

uma nachweislich zertifiziert

Die Grundprinzipien unserer Produktionsbedingungen sind klar: Wir sehen es als unternehmerische Verantwortung, menschenwürdige und umweltverträgliche Arbeitsbedingungen sicherzustellen. Somit haben das Einhalten von Arbeitnehmerrechten, sowie der verantwortungsbewusste Umgang mit der Natur und ihren Ressourcen oberste Priorität. Deshalb werden alle uma Produktionsstätten regelmäßig von externen Einrichtungen auditiert und unsere Ansprüche bei persönlichen Besuchen und Briefings den Zulieferern vermittelt. Die Zusammenarbeit mit diesen Produktionsstätten basieren auf jahrelangen und familiären Verbindungen, die ein zusätzliches Sicherheits- und Qualitätsniveau in allen Belangen sicherstellt.

uma demonstrably certified

The basic principles of our production conditions are clear: We see it as our corporate responsibility to ensure humane and environmentally compatible working conditions. Respect for workers' rights and the responsible use of nature and its resources are therefore our top priorities. Therefore, all uma production sites are regularly audited by external institutions and our requirements are communicated to the suppliers during personal visits and briefings. The cooperation with these production sites is based on long-standing and family ties, which ensure an additional level of safety and quality in all matters.



SEDEX
(Supplier Ethical
Data Exchange)



FTA
Foreign Trade Association

FTA
(Foreign Trade
Association)



The Mark of a Professional
PPAI
(Promotional Products
Association International)



Trade with purpose
BSCI
(Business Social
Compliance Initiative)



Gesamverband der
Werbearbeitel-Wirtschaft e.V.
GWV
(German Association of
the Promotional Products
Industry)



asi/92469
ASI
(Advertising Specialty
Institute)

Tradition basiert auf ständigen Innovationen

Bei dem Innovationswettbewerb TOP 100 hat uma es nach 2019 und 2022 auch in 2024 wieder unter die Besten geschafft. In einem unabhängigen Auswahlverfahren konnten wir besonders mit innovativen Prozessen und innovativem Management nachhaltig punkten. Dass sich zukunftssträchtiges Agieren auch in innovativen Produkten niederschlägt, konnte mit der uma RECYCLED PET PEN-Serie eindrucksvoll bewiesen werden. Der Einsatz alternativer Materialien und die Investition in neue Produktionsverfahren macht uma zu einem der TOP 100 innovativsten Unternehmen des deutschen Mittelstandes.



Tradition is based on constant innovation

In the TOP 100 innovation competition, uma made it to the top again in 2024 after 2019 and 2022. In an independent selection process, we scored particularly well with innovative processes and innovative management. With the uma RECYCLED PET PEN series, it was impressively demonstrated that future-oriented action is also reflected in innovative products. The use of alternative materials and the investment in new production processes make uma one of the TOP 100 most innovative companies in the German medium-sized sector.

umaNATURALS Serie ClimatePartner-zertifiziert



**ClimatePartner
zertifiziertes Produkt**
climate-id.com/DIPVA4

Der Klimawandel ist aktuell eine der größten Herausforderungen. Wir wollen Verantwortung übernehmen und leisten einen konkreten Beitrag zum Klimaschutz: In Zusammenarbeit mit ClimatePartner haben wir die Emissionen von unseren umaNATURALS berechnet und anschließend über regionale Klimaschutzprojekte ausgeglichen.



**ClimatePartner
zertifiziertes Unternehmen**
climate-id.com/XTENBG

Wir wären aber nicht uma, wenn wir uns nur auf ein Produkt konzentrieren würden. Aus diesem Grund haben wir die komplette Produktion in Fischerbach, im Herzen des Schwarzwaldes, auf ClimatePartner-zertifiziert gestellt. Wir freuen uns somit einen positiven Beitrag für die Umwelt leisten zu können.

umaNATURALS series ClimatePartner-certified



**ClimatePartner
certified product**
climate-id.com/DIPVA4

Climate change is currently one of the greatest challenges. We want to assume responsibility and make a concrete contribution to climate protection: In cooperation with ClimatePartner, we have calculated the emissions of our umaNATURALS then offset them through regional climate protection projects.



**ClimatePartner
certified company**
climate-id.com/XTENBG

But we wouldn't be uma if we only concentrated on one product. For this reason, we have set the complete production in Fischerbach, in the heart of the Black Forest, to ClimatePartner-certified. We are therefore pleased to be able to make a positive contribution to the environment.







Wie schreibt man „nachhaltig“?

Nachhaltigkeit – ein Thema, das uma schon seit vielen Jahren bewegt. Dies spiegelt sich nicht nur in unserer generationsübergreifenden und zukunftsorientierten Firmengeschichte wider, sondern auch in den innovativen uma Produktideen.

Mit den uma RECYCLED PET PEN-Serien haben wir die erste tatsächlich nachhaltige Schreibgeräte-Serie entwickelt, die nicht nur in Haptik und Variationsmöglichkeit, sondern auch mit einer innovativen Recyclingidee überzeugt.

Und das ist zertifiziert mit dem Global Recycled Standard zertifiziert.



How do you write 'sustainable'?

Sustainability – a topic that has been on umas' agenda for many years. This is reflected not only in our generation-spanning and future-oriented company history, but also in the innovative uma product ideas.

With the uma RECYCLED PET PEN series we have developed the first truly sustainable writing instrument series, which not only convinces in haptics and variation possibilities, but also with an innovative recycling idea.

And that's certified with the Global Recycled Standard.

uma RECYCLED PET PEN – ausgezeichnet!

Mit der Einführung des uma RECYCLED PET PEN hat uma nicht nur seine Innovationskraft unter Beweis gestellt, sondern auch eine neue Idee in Sachen Nachhaltigkeit geschaffen. Dafür wurde die uma RECYCLED PET PEN-Serie mit dem PSI Sustainability Award 2017 ausgezeichnet.

Für die Erweiterung der uma RECYCLED PET PEN PRO-Serie wurde uma zum Innovator of the Year Award nominiert und konnte den German Innovation Award 2021 mit der höchsten Auszeichnung GOLD gewinnen.

Mit der Nominierung zum Deutschen Nachhaltigkeitspreis 2019 wurde uma auch branchenextern bestätigt, zusätzlich zählt das Unternehmen zu den TOP 100 innovativsten Unternehmen im Deutschen Mittelstand.



uma RECYCLED PET PEN – awarded!

With the introduction of uma RECYCLED PET PEN, uma has not only proven its innovative strength, it has also created a new idea in terms of sustainability. The uma RECYCLED PET PEN series was awarded the PSI Sustainability Award 2017.

For the expansion of the uma RECYCLED PET PEN PRO series, uma was nominated for the Innovator of the Year Award and was able to win the German Innovation Award 2021 with the highest award GOLD.

With its nomination for the German Sustainability Award 2019, uma was also confirmed outside the industry. In addition, the company ranks among the TOP 100 most innovative companies in the German medium-sized sector.

Was bedeutet Nachhaltigkeit?

Nachhaltigkeit rückt immer stärker in das Bewusstsein der Menschen und gewinnt für Kaufentscheidungen von Produkten immer mehr an Bedeutung. Für uns bei uma Schreibgeräte bedeutet das, bei allem was wir heute tun, schon an die Zukunft zu denken. So sorgen wir dafür, dass Plastikflaschen zu Kugelschreibern recycelt werden und Bäume nur in der Anzahl gefällt werden, in der neue Bäume nachgepflanzt werden.

What does sustainability really mean?

Sustainability is becoming increasingly important in the public consciousness and even more decisive in driving purchasing decisions. Here at uma, this means that, for everything that we do today, we think about how it impacts the future. It means that we recycle plastic bottles into ballpoint pens and that we don't cut down more trees than can be planted.



rPET – recycelte PET-Flasche rPET – recycled PET bottle

Für die Herstellung eines PET Kugelschreibers wird recyceltes PET verwendet. Das hierzu benötigte Granulat wird aus recycelten PET-Flaschen gewonnen. Eine 0,5 Liter PET-Flasche ergibt genau das Material, welches für die Herstellung eines Kugelschreibergehäuses benötigt wird – „Upcycling“ in seiner besten Form.

Recycled PET is used to manufacture a PET ballpoint pen. The required granulate is obtained from recycled PET bottles. A 0.5 litre PET bottle produces exactly the material required for the production of a ballpoint pen housing – “upcycling” in its best form.



rABS – recycelter Kunststoff rABS – recycled plastic

Recycelter ABS-Kunststoff wird aus industriellen **Spritzgussresten** hergestellt. Hierzu werden die Kunststoffabfälle gesammelt und dem Spritzgussprozess wieder zugeführt. Die gesammelten Kunststoffe können sortenrein und qualitätsbestimmt gesammelt werden. Durch das Aufbereiten der Kunststoffe kann aus diesen ein recyceltes Produkt gefertigt werden. Generell wird durch das Recyceln der Kunststoffe weniger Rohöl und Energie verbraucht.

Recycled ABS plastic is made from industrial **injection moulding offcuts**. For this, plastic waste is collected up and directed back into the injection moulding process. The collected plastics can be collected, graded and grouped by quality standard. These preparatory operations with plastics are the key to manufacturing a recycled product. Without exception, the recycling of plastics uses less crude oil and power.



rPCP – recycelter Post Consumer Kunststoff rPCP – recycled post consumer plastic

Recycelter Post-Consumer-Kunststoff (PCP) wird meist aus technischen (Haushalts-) Geräten oder sonstigen **Consumer Kunststoffabfällen** gewonnen. Hierzu werden die Kunststoffe gesammelt und sortenrein recycelt. Die sogenannten Post Consumer oder Post Industry Kunststoffe können nach der Aufbereitung in ein neues Produkt upgecycelt werden. Generell wird durch das Recyceln der Kunststoffe weniger Rohöl und Energie verbraucht.

For the most part, recycled post-consumer plastic (PCP) is obtained from technical (domestic) appliances or other forms of **plastic consumer waste**. This process involves collecting and grading plastics and recycling each grade separately. After the recycling process, a new product can be ‘upcycled’ from what are known as post-consumer or also post industry plastics. Without exception, the recycling of plastics uses less crude oil and power.

Allgemein/in general

Produktionen aus recycelten bzw. biobasierenden Kunststoffen können produktionstechnische Farbschwankungen unterliegen oder Einfallstellen aufweisen. Diese Material- bzw. Produktionsmerkmale sind kein Reklamationsgrund.

Products made from recycled or bio-based plastics may show colour variations or imperfections. These material or manufacturing characteristics do not provide valid grounds for complaints.



Holz/wood

Für die uma Schreibgeräte aus Holz wird ausschließlich PEFC- oder FSC®-zertifiziertes Holz verwendet. Durch spezielle Bearbeitung des nachwachsenden Rohstoffs transportiert das Naturprodukt Ihre Werbebotschaft edel und formschön zum Kunden. Der Naturstoff Holz variiert sowohl in der Farbigkeit des Holzes als auch in der Struktur (Maserung).

Only PEFC or FSC® certified wood is used for the uma writing utensils made of wood. Through special processing of the sustainable raw material, the natural product transports its advertising message in a refined and beautiful design to the customer. Wood is a natural material with a great variety of colours and textures (grain effect).



Cellulose/cellulose acetate

Der aus der Natur gewonnene Rohstoff kann dieser ebenfalls wieder zugeführt werden. Das Celluloseacetat entspricht der DIN EN 13432:2000-12/Zertifizierungsprogramm für Produkte aus kompostierbaren Werkstoffen. Die hierfür notwendige Cellulose wird aus europäischen Weichhölzern gewonnen.

The raw material gained from nature can also be returned to nature. The cellulose acetate complies with DIN EN 13432:2000-12/certification program for products from compostable materials. The cellulose required for this is gained from European softwoods.

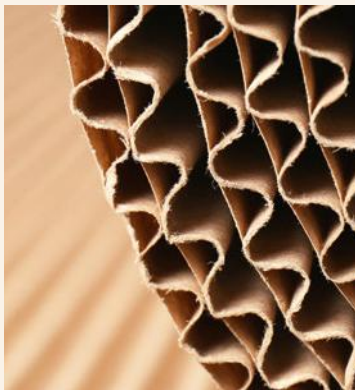

recycelter Karton/recycled cardboard

Die Verwendung von bereits recycelter Kartonage bietet eine stabile und zugleich umweltverträgliche Grundlage für die Herstellung von Schreibgeräten. Das Material kann dem Recyclingprozess wieder zugeführt werden und trägt so zur Umweltschonung bei. Die Verwendung dieser besonderen Materialien unterliegt produktionstechnischen Schwankungen. Leichte Unterschiede in Farbe und Oberfläche sind daher möglich.

The use of cardboard that has already been recycled offers a stable and at the same time environmentally friendly basis for the production of writing utensils. The material can be returned to the recycling process again, thus contributing to helping the environment. The use of these special materials is subject to fluctuations in the production technology. As a result, slight differences in colour and surface are possible.

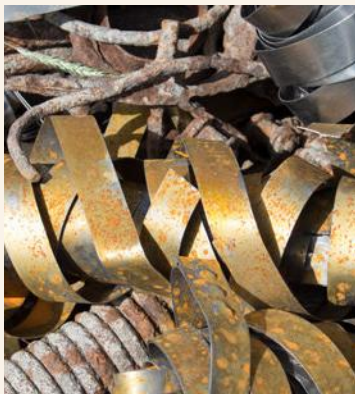

Metall RECY – recyceltes Metall Metal RECY – recycled metal

Das recycelte Metall wird aus bereits vorhandenen Materialien gewonnen, was dazu beiträgt, den Verbrauch von neuen Ressourcen zu reduzieren und Abfälle zu minimieren. Durch die Verwendung von recycelten Materialien wird die Belastung der Umwelt verringert und Ressourcen geschont. Dank der ClimatePartner-zertifizierten Produktion leisten die uma Metall RECY Schreibgeräte einen zusätzlichen nachhaltigen Beitrag zur Schonung der Umwelt.

The recycled metal is obtained from existing materials, which helps to reduce the consumption of new resources and minimise waste. By using recycled materials, the impact on the environment is reduced and resources are conserved. Thanks to the ClimatePartner-certified production, the uma Metal RECY writing instruments make an additional sustainable contribution to the protection of the environment.



Aluminium RECY – recyceltes Aluminium Aluminium RECY – recycled aluminium

Recyceltes Aluminium wird aus bereits bestehenden Aluminiumprodukten gewonnen und hilft, den Bedarf an neuen Rohstoffen zu verringern. Diese Methode reduziert sowohl den Energieverbrauch als auch den CO₂-Ausstoß, da weniger Energie für die Herstellung erforderlich ist. Dank der ClimatePartner-zertifizierten Produktion leisten die uma Aluminium RECY Schreibgeräte einen zusätzlichen Beitrag zur Schonung der Umwelt.

Recycled aluminium is obtained from existing aluminium products and helps to reduce the need for new raw materials. This method reduces both energy consumption and CO₂ emissions, as less energy is required for production. Thanks to ClimatePartner-certified production, uma aluminium RECY writing instruments make an additional sustainable contribution to the protection of the environment.

Die uma RECYCLED PET PEN-Serie

Schreiben Sie mit der ersten in Europa gefertigten, ClimatePartner-zertifizierten, recycelten, nachhaltigen Schreibgeräte-Serie. Die uma RECYCLED PET PEN-Serie.

Mit Innovationen Werben

Die verschiedenen Schreibsysteme, neben dem klassischen Kugelschreiber, basieren alle auf einem eigens entwickelten und innovativen Tintenleitsystem. Die Patronen können in allen Schreibgeräten ausgewechselt und nachgerüstet werden. Langlebiges Schreiben und Werben ist somit garantiert. Die Kombination aus Schreibsystemen und recyceltem PET-Material macht die uma RECYCLED PET PEN-Serie zu einer Weltneuheit. Die erste nachhaltige Schreibgeräte-Serie aus recyceltem PET-Material, die komplett ClimatePartner-zertifiziert produziert wird, verleiht den werbenden Unternehmen in der Kommunikation nicht nur Nachhaltigkeit, sondern auch geschriebene Innovation. Die nachhaltige Schreibgeräte-Familie, uma RECYCLED PET PEN, verspricht Werbekommunikation und Schreibvergnügen auf höchstem Niveau.



The uma RECYCLED PET PEN series

Write with the first European, ClimatePartner-certified, recycled and sustainable produced writing instrument series. The uma RECYCLED PEN series.

Advertising with innovations

Along with the classic ballpoint pen, the various writing systems are all based on a specially developed and innovative ink flow system. The cartridges can be used and retrofitted. This guarantees long-lasting writing joy and appeal. The combination of writing systems and recycled PET material makes the uma RECYCLED PET PEN series a world first. The first sustainable writing series made from recycled PET material, which is produced completely ClimatePartner-certified, gives companies looking to communicate attractively sustainable and written innovation. The sustainable uma RECYCLED PET PEN series guarantees promotional communication and an enjoyable writing experience of the highest quality.

Nachhaltigkeit kombiniert mit innovativer Schreibtechnologie – Das uma Tintenleitsystem

Dank der innovativen Weiterentwicklung der uma RECYCLED PET PEN PRO-Serie ergeben sich zusätzliche Varianten von Schreibsystemen und Werbeoptionen für den Kunden. Neben dem klassischen Kugelschreiber können weitere Schreibsysteme im identischen Design, aus recyceltem PET-Material mit den gleichen, identischen Nachhaltigkeitsvorteilen umgesetzt werden.





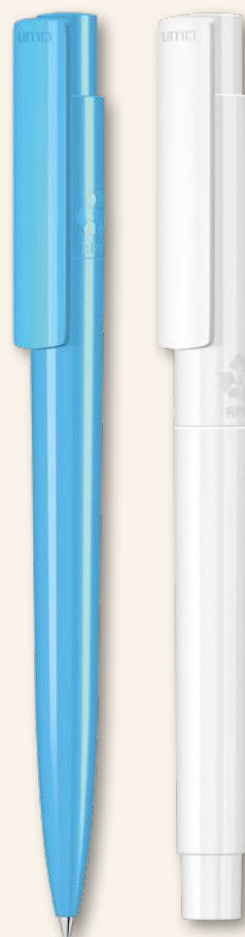

Sustainably combined with innovative writing technology – The uma ink flow system

Thanks to the innovative further development of the uma RECYCLED PET PEN PRO series, additional types of writing system and promotional options have been created for customers. Along with the classic ballpoint pen, other identical writing systems made from recycled PET material can be used with the exact same sustainability benefits.



Schreiben auch Sie Verantwortung! / Communicate your responsibility too!

Schreiben Sie: Die uma RECYCLED PET PEN-Serie mit folgenden Pro Argumenten
 Communicate: The uma RECYCLED PET PEN series with the following pro arguments

 <ul style="list-style-type: none"> • Weltneuheit: Erste in Europa gefertigte, recycelte, ClimatePartner-zertifizierte Schreibgeräte-Serie aus rPET- Material • Ein Recyclingprozess wurde bereits durchlaufen. • World first: First recycled, ClimatePartner-certified writing series produced from rPET material and made in Europe • One recycling process has already been completed. 	 <ul style="list-style-type: none"> • rPET-Material zu 100 % aus recycelten PET-Flaschen • Eine 0,5 l PET-Flasche ergibt genau ein Schreibgerätegehäuse • Langlebiges, nachhaltiges Material – eignet sich zum Upcycling • rPET material made 100 % from recycled PET bottles • One 0,5 l PET bottle produces exactly one housing of a pen • Long-lasting, sustainable material – suitable for upcycling
 <ul style="list-style-type: none"> • Es werden ausschließlich PET-Flaschen aus Europa verwendet (außer Ocean Bound Plastic). • Made in Europe • Only PET bottles from Europe are used (excepted ocean-bound plastic). • Made in Europe 	 <ul style="list-style-type: none"> • Optimaler CO₂-Fußabdruck • ClimatePartner-zertifizierte Produktion und Veredelung • Low carbon footprint • ClimatePartner-certified production and processing
 <ul style="list-style-type: none"> • Alle Schreibgeräte sind mit dem international bekannten „rPET RECY-Zeichen“ versehen • Kann einem weiteren Recyclingprozess zugeführt werden • All stationery features the internationally recognised “rPET RECY logo” • Can be recycled further 	 <ul style="list-style-type: none"> • Designs auch als antibakterielle und antivirale Variante erhältlich, zertifiziert nach ISO 22196 (antibakteriell) und nach ISO 21702 (antiviral) • #gesundbleiPEN – Hygiene- und Nachhaltigkeitskonzept werden mit einem Schreibgerät erfüllt • Designs also available as antibacterial an antiviral version, certified according to ISO 22196 (antibacterial) and to ISO 21702 (antiviral) • #antibacterial – hygiene and sustainability concept are fulfilled with one writing instrument



- Einzigartige Gehäusefarbpalette, zusätzliche Einfärbung nach PMS und Mix n' Match-Service
- Unique housing colour range, additional colouring based on PMS and Mix n' Match service

Vier Schreibsysteme – ein Design

- **Kugelschreiber** mit Dokumental® Schreibpaste ●●
- **Rollerball** ●●●●●●●●
- **Highlighter** mit Dokumental® Highlighterpaste, EN-71-3, ASTM D4326 ●●●●●●●●
- **Fineliner** mit Dokumental® Finelinerpaste, EN-71-3, ASTM D4326 ●●●●●●●●●●●●●●



Four writing systems – one design

- **Ballpoint pen** with Dokumental® writing ink ●●
- **Rollerball** ●●●●●●●●
- **Highlighter** with Dokumental® highlighter ink, EN-71-3, ASTM D4326 ●●●●●●●●
- **Fineliner** with Dokumental® finelinerpaste, EN-71-3, ASTM D4326 ●●●●●●●●●●●●●●



- Geschlossener und kontrollierter Recycling- bzw. Produktionsprozess nach dem „Global Recycling Standard“ zertifiziert

- Zertifizierte und ausgezeichnete Idee

- Closed and controlled recycling and production process certified based on the “Global Recycling Standard”
- Certified and award-winning concept



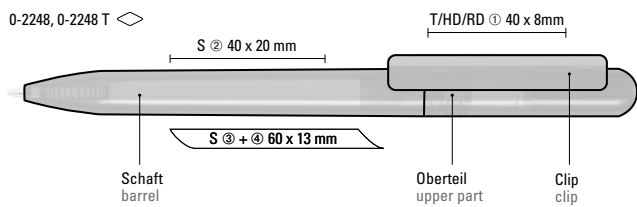





























Farb-Code/Minen
Colour code/Refills

RECYCLED PET PEN CHANGE
0-2248 **new!**

RECYCLED PET PEN CHANGE transparent
0-2248 T **new!**

0-2248 (● 8-0854)	0-2248 T (● 8-0854)
 57-0298	 57-0286
 57-0662	 57-0185
 57-0200	 57-0355
 57-7492	 57-0440
 57-0361	 57-0291
 57-0340	 57-0107
 57-0002	 57-0260
 57-7527	 57-0226
 57-0001	 57-0151
 57-0012	 57-3295
 57-0270	 ● 8-0854
 57-2607	
 57-0233	
 57-0021	
 57-7710	
 57-7500	
 ● 8-0854	



Aufgrund der Besonderheiten des Materials (recyceltes PET-Material) sind produktionstechnische Farbschwankungen gegeben.

Due to the special nature of the material (recycled PET material) production-related variations are possible.

Das aus recycelten PET-Flaschen in Europa hergestellte rPET-Material eignet sich für einen langlebigen und nachhaltigen Werbeeinsatz. Dank der europäischen und ClimatePartner-zertifizierten Produktion leistet der uma RECYCLED PET PEN CHANGE einen zusätzlichen nachhaltigen Beitrag zur Schonung der Umwelt.

The rPET material, which is produced in Europe from recycled PET bottles, is suitable for a durable and sustainable advertisement. Thanks to the European and ClimatePartner-certified production, the uma RECYCLED PET PEN CHANGE makes an additional sustainable contribution to the protection of the environment.



0-2248: Drehkugelschreiber aus recyceltem PET-Material mit gedeckt glänzendem Gehäuse.

0-2248 T: Drehkugelschreiber aus recyceltem PET-Material mit transparent glänzendem Gehäuse.

Preis/Stück 0-2248	0,49 €
Preis/Stück 0-2248 T	0,49 €
Menge	1.000 Stück
Werbeschlüssel	Schaft S, Clip T/HD/RD

0-2248: Twist ballpoint pen made from recycled PET material with opaque glossy housing.

0-2248 T: Twist ballpoint pen made from recycled PET material with transparent glossy housing.

Price/piece 0-2248	0.49 €
Price/piece 0-2248 T	0.49 €
Quantity	1,000 pieces
Advertising code	barrel S, clip T/HD/RD

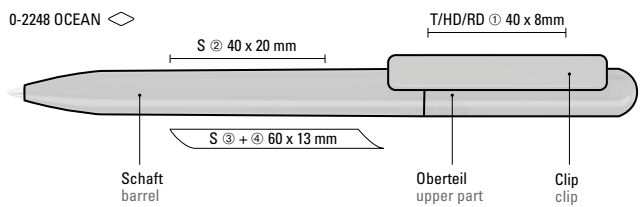

Farb-Code/Minen
Colour code/Refills

RECYCLED PET PEN CHANGE ocean
0-2248 OCEAN **new!**

0-2248 OCEAN (● 8-0854)

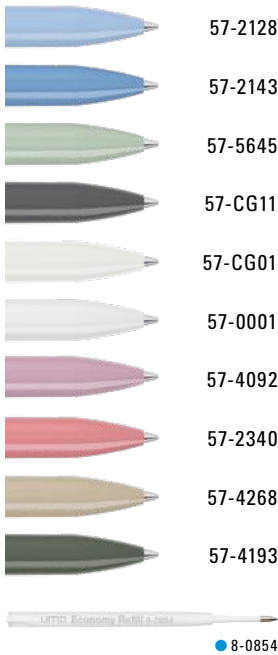

Aufgrund der Besonderheiten des Materials (recycliertes PET-Material) sind produktionstechnische Farbschwankungen gegeben.

Due to the special nature of the material (recycled PET material) production-related variations are possible.

Das durch Plastic Bank gesammelte Ocean Bound Plastic, auch bekannt als Social Plastic®, wird in Europa zu einem recycelten PET Schreibgerät für einen langlebigen und nachhaltigen Werbeeinsatz upgecyclt. Dank der europäischen und ClimatePartner-zertifizierten Produktion leistet der uma RECYCLED PET PEN CHANGE ocean einen zusätzlichen nachhaltigen Beitrag zur Schonung der Umwelt.

Ocean-bound plastic, also known as Social Plastic®, collected through Plastic Bank is upcycled in Europe into a recycled PET writing instrument for long-lasting and sustainable advertisement. Thanks to the European and ClimatePartner-certified production, the uma RECYCLED PET PEN CHANGE ocean makes an additional sustainable contribution to the protection of the environment.

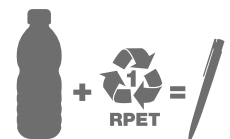
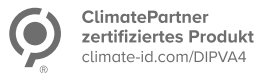

made from ocean-bound plastic

0-2248 OCEAN: Drehkugelschreiber aus recyceltem PET-Material aus Ocean Bound Plastic mit gedeckt glänzendem Gehäuse.

Preis/Stück 0,52 €
Menge 1.000 Stück
Werbeschlüssel Schaft S, Clip T/HD/RD

0-2248 OCEAN: Twist ballpoint pen made from ocean-bound PET material with opaque glossy housing.

Price/piece 0.52 €
Quantity 1,000 pieces
Advertising code barrel S, clip T/HD/RD

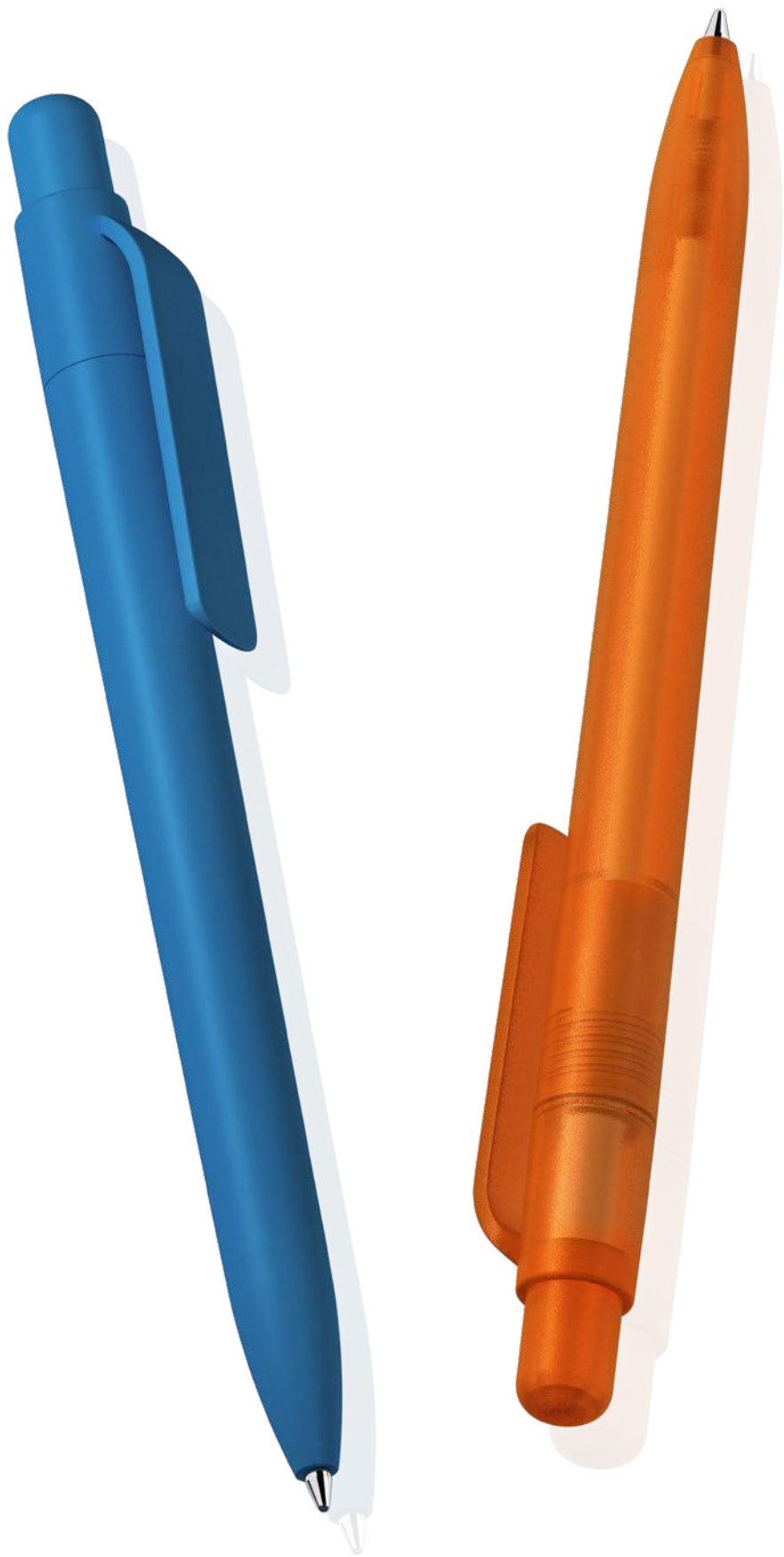

0-2217 F, 0-2217 TF ◊

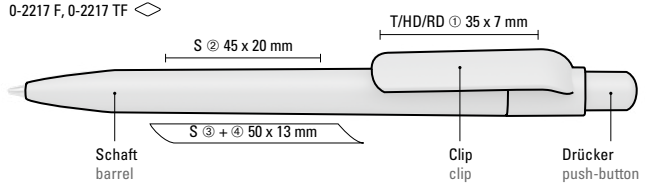

Farb-Code/Minen
Colour code/Refills

RECYCLED PET PEN FUTURE F
0-2217 F

RECYCLED PET PEN FUTURE frozen
0-2217 TF

0-2217 F (● 8-0866) 0-2217 TF (● 8-0866)



Aufgrund der Besonderheiten des Materials (recyceltes PET-Material) sind produktionstechnische Farbschwankungen gegeben.

Due to the special nature of the material (recycled PET material) production-related variations are possible.



Köcher Empfehlung/
Cup suggestion
RECYCLED PET BOX 0-2225
Seite 89/page 89



Das in Europa hergestellte rPET-Material eignet sich für einen langlebigen und nachhaltigen Werbeeinsatz. Dank der europäischen und ClimatePartner-zertifizierten Produktion leistet der uma RECYCLED PET PEN FUTURE einen zusätzlichen nachhaltigen Beitrag zur Schonung der Umwelt.

The rPET material, which is produced in Europe, is suitable for a durable and sustainable advertisement. Thanks to the European and ClimatePartner-certified production, the uma RECYCLED PET PEN FUTURE makes an additional sustainable contribution to the protection of the environment.



0-2217 F: Druckkugelschreiber aus recyceltem PET-Material mit matt gedecktem Schaft, Clip, Drücker und Stopfen.

0-2217 TF: Druckkugelschreiber aus recyceltem PET-Material mit gefrostetem Schaft, Clip, Drücker und Stopfen.

0-2217 F: Retractable ballpoint pen made from recycled PET material with opaque matt housing, clip, push-button and plug.

0-2217 TF: Retractable ballpoint pen made from recycled PET material with transparent frosted housing, clip, push-button and plug.

Preis/Stück 0-2217 F 0,69 €
Preis/Stück 0-2217 TF 0,69 €
Menge 1.000 Stück
Werbeschlüssel Schaft S, Clip T/HD/RD

Price/piece 0-2217 F 0.69 €
Price/piece 0-2217 TF 0.69 €
Quantity 1,000 pieces
Advertising code barrel S, clip T/HD/RD

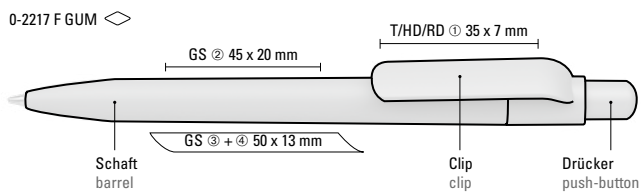

0-2217 F GUM (● 8-0866)

	32-2175
	32-7686
	32-1805
	32-0382
	32-0348
	32-0343
	32-0002
	32-0428
	32-0115
	32-1585
	32-0638
	● 8-0866



Aufgrund der Besonderheiten des Materials (recyceltes PET-Material) sind produktionstechnische Farbschwankungen gegeben.

Due to the special nature of the material (recycled PET material) production-related variations are possible.



Das in Europa hergestellte rPET-Material eignet sich für einen langlebigen und nachhaltigen Werbeeinsatz. Dank der europäischen und ClimatePartner-zertifizierten Produktion leistet der uma RECYCLED PET PEN FUTURE einen zusätzlichen nachhaltigen Beitrag zur Schonung der Umwelt.

The rPET material, which is produced in Europe, is suitable for a durable and sustainable advertisement. Thanks to the European and ClimatePartner-certified production, the uma RECYCLED PET PEN FUTURE makes an additional sustainable contribution to the protection of the environment.



0-2217 F GUM: Druckkugelschreiber aus recyceltem PET-Material mit Softtouch-Schaft und gedeckt mattem Clip, Drücker und Stopfen.

Preis/Stück 0,91 €
Menge 1.000 Stück
Werbeschlüssel Schaft GS, Clip T/HD/RD

0-2217 F GUM: Retractable ballpoint pen made from recycled PET material with softtouch housing and opaque matt clip, push-button and plug.

Price/piece 0.91 €
Quantity 1,000 pieces
Advertising code barrel GS, clip T/HD/RD



0-2210 F GUM

(● 8-0854)

- 57-0298
- 57-0662
- 57-0200
- 57-0361
- 57-0340
- 57-0002
- 57-7527
- 57-0012
- 57-0021
-

● 8-0854

Das aus recycelten PET-Flaschen in Europa hergestellte rPET-Material eignet sich für einen langlebigen und nachhaltigen Werbeeinsatz. Dank der europäischen und ClimatePartner-zertifizierten Produktion leistet der uma RECYCLED PET PEN STEP einen zusätzlichen nachhaltigen Beitrag zur Schonung der Umwelt.

The rPET material, which is produced in Europe from recycled PET bottles, is suitable for a durable and sustainable advertisement. Thanks to the European and ClimatePartner-certified production, the uma RECYCLED PET PEN STEP makes an additional sustainable contribution to the protection of the environment.

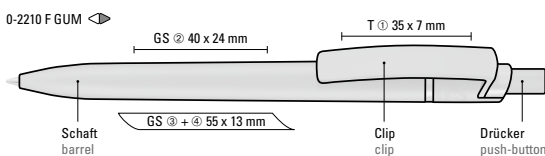

Mix n' Match: Ab 2.000 Stück kann das Modell farblich kombiniert werden.

0-2210 F GUM: Druckkugelschreiber mit gummiertem Gehäuse aus recyceltem PET-Material mit matt gedecktem Clip und Drücker.

Preis/Stück 0,69 €
Menge 1.000 Stück
Werbeschlüssel Schaft GS, Clip T

Mix n' Match: From 2,000 pieces, you can choose any colour combination.

0-2210 F GUM: Retractable ballpoint pen with softtouch housing made from recycled PET material with opaque matt clip and push-button.

Price/piece 0.69 €
Quantity 1,000 pieces
Advertising code barrel GS, clip T

Farb-Code/Minen
Colour code/Refills

RECYCLED PET PEN STEP F
0-2210 F

RECYCLED PET PEN STEP frozen
0-2210 TF

0-2210 F		0-2210 TF	
● 8-0854		● 8-0854	
	57-0298		57-0286
	57-0662		57-0185
	57-0200		57-0355
	57-0361		57-0440
	57-0340		57-0291
	57-0002		57-0107
	57-7527		57-0260
	57-0001		57-0226
	57-0012		57-0151
	57-0021		57-3295
	● 8-0854		● 8-0854



Aufgrund der Besonderheiten des Materials (recyceltes PET-Material) sind produktionstechnische Farbschwankungen gegeben.

Due to the special nature of the material (recycled PET material) production-related variations are possible.

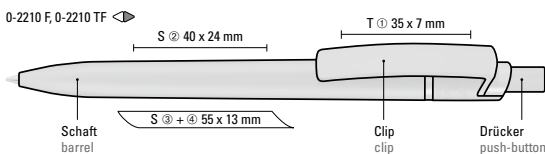

Mix n' Match: Ab 2.000 Stück kann das Modell farblich kombiniert werden.

0-2210 F: Druckkugelschreiber aus recyceltem PET-Material mit matt gedecktem Gehäuse, Clip und Drücker.

0-2210 TF: Druckkugelschreiber aus recyceltem PET-Material mit transparent gefrostetem Gehäuse, Clip und Drücker.

Preis/Stück 0-2210 F	0,48 €
Preis/Stück 0-2210 TF	0,48 €
Menge	1.000 Stück
Werbeschlüssel	Schaft S, Clip T

Mix n' Match: From 2,000 pieces, you can choose any colour combination.

0-2210 F: Retractable ballpoint pen made from recycled PET material with opaque matt housing, clip and push-button.

0-2210 TF: Retractable ballpoint pen made from recycled PET material with transparent frosted housing, clip and push-button.

Price/piece 0-2210 F	0.48 €
Price/piece 0-2210 TF	0.48 €
Quantity	1,000 pieces
Advertising code	barrel S, clip T



0-2250 F-SI GUM ◊

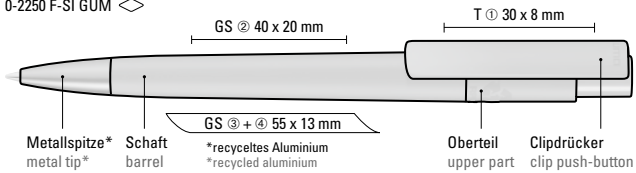

0-2250 KT GUM ◊

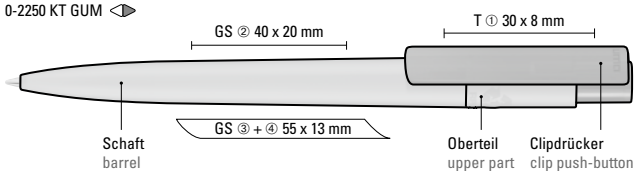

Farb-Code/Minen
Colour code/Refills

RECYCLED PET PEN PRO F SI GUM
0-2250 F-SI GUM

RECYCLED PET PEN PRO K transparent GUM
0-2250 KT GUM

0-2250 F-SI GUM (● 8-0855)



57-0002



● 8-0855

0-2250 KT GUM (● 8-0854)



57-0662



57-0200



57-0340



57-0002



57-0012



57-2607



57-0233



57-0021



57-7710



● 8-0854



Aufgrund der Besonderheiten des Materials (recyceltes PET-Material) sind produktionstechnische Farbschwankungen gegeben.

Due to the special nature of the material (recycled PET material) production-related variations are possible.

Die Gewinnung und Verarbeitung des rPET-Materials aus 100% recycelten PET-Flaschen sowie das rAL-Material aus 100% recycelten Aluminium-Getränkedosen findet in Europa statt. Die beiden Materialien eignen sich für einen langlebigen und nachhaltigen Werbeeinsatz. Dank der europäischen und ClimatePartner-zertifizierten Produktion leisten die uma RECYCLED PET PEN PRO einen zusätzlichen nachhaltigen Beitrag zur Schonung der Umwelt.

The extraction and processing of the rPET material from 100% recycled PET bottles, as well as the rAL material from 100% recycled aluminium beverage cans takes place in Europe. Both materials are suitable for a durable and sustainable advertisement. Thanks to the European and ClimatePartner-certified production, the uma RECYCLED PET PEN PRO make an additional sustainable contribution to the protection of the environment.



ClimatePartner
zertifiziertes Produkt
climate-id.com/DIPVA4



Mix n' Match: Ab 2.000 Stück kann das Modell farblich kombiniert werden.

0-2250 F-SI GUM: Druckkugelschreiber mit gummiertem Gehäuse aus recyceltem PET-Material mit matt gedecktem Clip sowie Metallspitze aus recyceltem Aluminium in silber matt.

0-2250 KT GUM: Druckkugelschreiber mit gummiertem Gehäuse aus recyceltem PET-Material mit transparent glänzendem Clip.

Preis/Stück 0-2250 F-SI GUM	1,23 €
Preis/Stück 0-2250 KT GUM	0,95 €
Menge	1.000 Stück
Werbeschlüssel	Schaft GS, Clip T

Mix n' Match: From 2,000 pieces, you can choose any colour combination.

0-2250 F-SI GUM: Retractable ballpoint pen with softtouch housing made from recycled PET material with opaque matt clip, metal tip made from recycled aluminium in matt silver.

0-2250 KT GUM: Retractable ballpoint pen with softtouch housing made from recycled PET material with transparent glossy clip.

Price/piece 0-2250 F-SI GUM	1.23 €
Price/piece 0-2250 KT GUM	0.95 €
Quantity	1,000 pieces
Advertising code	barrel GS, clip T

RECYCLED PET PEN PRO
0-2250

RECYCLED PET PEN PRO F
0-2250 F

Farb-Code/Minen
Colour code/Refills



UMA
PRIME



0-2250 (● 8-0854)
0-2250 F (● 8-0854)

- 57-0298
- 57-0662
- 57-0200
- 57-7492
- 57-0361
- 57-0340
- 57-0002
- 57-7527
- 57-0001
- 57-0012
- 57-0270
- 57-2607
- 57-0233
- 57-0021
- 57-7710
- 57-7500
-
- 8-0854

Aufgrund der Besonderheiten des Materials (recyceltes PET-Material) sind produktionstechnische Farbschwankungen gegeben.

Due to the special nature of the material (recycled PET material) production-related variations are possible.

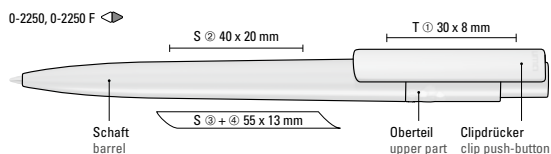

Mix n' Match: Ab 2.000 Stück kann das Modell farblich kombiniert werden.

0-2250: Druckkugelschreiber aus recyceltem PET-Material mit gedeckt glänzendem Gehäuse und Clip.

0-2250 F: Druckkugelschreiber aus recyceltem PET-Material mit matt gedecktem Gehäuse und Clip.

Preis/Stück 0-2250 0,59 €
 Preis/Stück 0-2250 F 0,59 €
 Menge 1.000 Stück
 Werbeschlüssel Schaft S, Clip T

Mix n' Match: From 2,000 pieces, you can choose any colour combination.

0-2250: Retractable ballpoint pen made from recycled PET material with opaque glossy housing and clip.

0-2250 F: Retractable ballpoint pen made from recycled PET material with opaque matt housing and clip.

Price/piece 0-2250 0.59 €
 Price/piece 0-2250 F 0.59 €
 Quantity 1,000 pieces
 Advertising code 82250 S T

Farb-Code/Minen
Colour code/Refills

RECYCLED PET PEN PRO transparent
0-2250 T

RECYCLED PET PEN PRO frozen
0-2250 TF

0-2250 T (● 8-0854)
0-2250 TF (● 8-0854)



Etui Empfehlung / Case suggestion
ETUI 0-0955 rPET
Seite 90/page 90



Das aus recycelten PET-Flaschen in Europa hergestellte rPET-Material eignet sich für einen langlebigen und nachhaltigen Werbeeinsatz. Dank der europäischen und ClimatePartner-zertifizierten Produktion leistet der uma RECYCLED PET PEN PRO einen zusätzlichen nachhaltigen Beitrag zur Schonung der Umwelt.

The rPET material, which is produced in Europe from recycled PET bottles, is suitable for a durable and sustainable advertisement. Thanks to the European and ClimatePartner-certified production, the uma RECYCLED PET PEN PRO makes an additional sustainable contribution to the protection of the environment.



0-2250 T, 0-2250 TF ◀▶

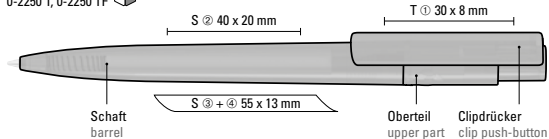

Mix n' Match: Ab 2.000 Stück kann das Modell farblich kombiniert werden.

0-2250 T: Druckkugelschreiber aus recyceltem PET-Material mit transparent glänzendem Gehäuse und Clip.

0-2250 TF: Druckkugelschreiber aus recyceltem PET-Material mit transparent gefrostetem Gehäuse und Clip.

Preis/Stück 0-2250 T	0,59 €
Preis/Stück 0-2250 TF	0,59 €
Menge	1.000 Stück
Werbeschlüssel	Schaft S, Clip T

Mix n' Match: From 2,000 pieces, you can choose any colour combination.

0-2250 T: Retractable ballpoint pen made from recycled PET material with transparent glossy housing and clip.

0-2250 TF: Retractable ballpoint pen made from recycled PET material with transparent frosted housing and clip.

Price/piece 0-2250 T	0.59 €
Price/piece 0-2250 TF	0.59 €
Quantity	1,000 pieces
Advertising code	barrel S, clip T

RECYCLED PET PEN PRO R
0-2252 R

RECYCLED PET PEN PRO FL
0-2254 FL

Farb-Code/Minen
Colour code/Refills

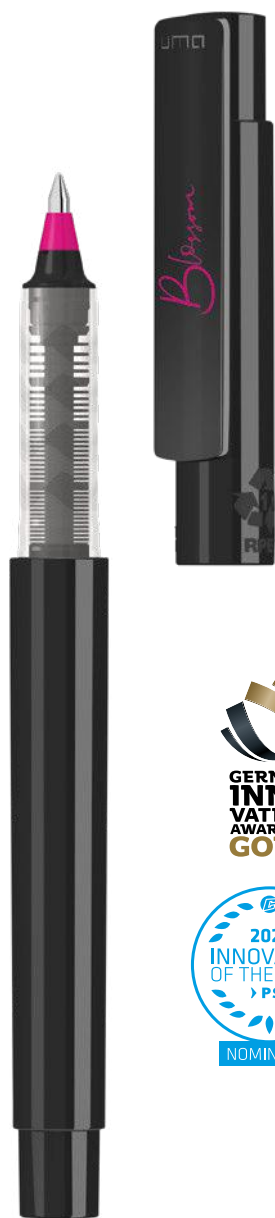

0-2252 R

0-2254 FL

57-0002



57-0002



57-0001



57-0001



Tintenleitsystem/
ink flow system

Tintenleitsystem/
ink flow system

57-0298



57-0298



57-0662



57-0662



57-0200



57-0200



57-0361



57-7492



57-0002



57-0361



57-2607



57-0002



57-0233



57-7527



57-0021



57-0012



57-2607

57-0233

57-0021

57-0478



0-2252 R



0-2254 FL

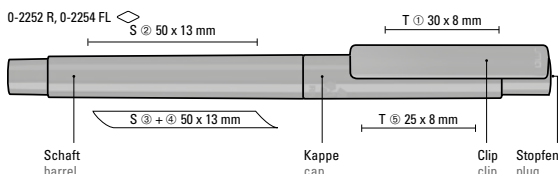

ClimatePartner
zertifiziertes Produkt
climate-id.com/DIPVA4



0-2252 R: Rollerball mit Gehäuse aus recyceltem PET-Material in gedeckt glänzend weiß oder schwarz. Stopfen in den 8 möglichen Schreibfarben.

0-2254 FL: Fineliner mit Gehäuse aus recyceltem PET-Material in gedeckt glänzend weiß oder schwarz. Stopfen in den 12 möglichen Schreibfarben.

Preis/Stück 0-2252 R

1,08 €

Preis/Stück 0-2254 FL

1,08 €

Menge

1.000 Stück

Werbeschlüssel

Schaft S, Clip T, Kappe T

0-2252 R: Rollerball with opaque glossy housing in white or black made from recycled PET material. Plug in 8 possible writing colours.

0-2254 FL: Fineliner with opaque glossy housing in white or black made from recycled PET material. Plug in 12 possible writing colours.

Price/piece 0-2252 R

1.08 €

Price/piece 0-2254 FL

1.08 €

Quantity

1,000 pieces

Advertising code

barrel S, clip T, cap T

Farb-Code/Minen
Colour code/Refills

RECYCLED PET PEN PRO LIQEO
0-2255

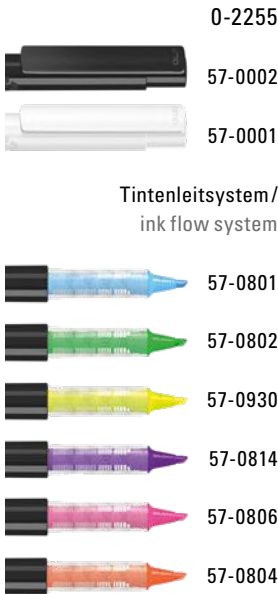

Tintenleitsystem/
ink flow system



0-2255



Das aus recycelten PET-Flaschen in Europa hergestellte rPET-Material eignet sich für einen langlebigen und nachhaltigen Werbeeinsatz. Dank der europäischen und ClimatePartner-zertifizierten Produktion leistet der uma RECYCLED PET PEN PRO einen zusätzlichen nachhaltigen Beitrag zur Schonung der Umwelt. Aufgrund der Besonderheiten des Materials (recyceltes PET-Material) sind produktionstechnische Farbschwankungen gegeben.

The rPET material, which is produced in Europe from recycled PET bottles, is suitable for a durable and sustainable advertisement. Thanks to the European and ClimatePartner-certified production, the uma RECYCLED PET PEN PRO makes an additional sustainable contribution to the protection of the environment. Due to the special nature of the material (recycled PET material) production-related variations are possible.

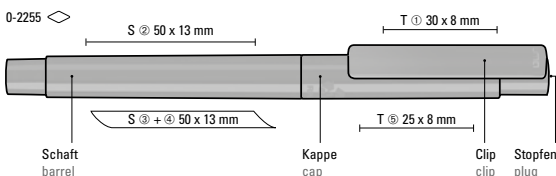

0-2255: Flüssig-Textmarker mit Gehäuse aus recyceltem PET-Material in gedeckt glänzend weiß oder schwarz. Stopfen in den 6 möglichen Schreibfarben. Der Highlighter ist ohne Pumpen oder Anstechen sofort einsatzfähig. Neues Flüssigtintenleitsystem – Bessere Schreibqualität – Höhere Leuchtkraft – Längere Schreibdauer – Umweltfreundlicher – Produziert nach EN-71, ASTM D-4236 – Flüssigtank austausch- bzw. nachfüllbar.

Preis/Stück 1,08 €
Menge 1.000 Stück
Werbeschlüssel Schaft S, Clip T, Kappe T



0-2255: Liquid highlighter with opaque glossy housing in white or black made from recycled PET material. Plug in 6 possible writing colours. Writes longer and more intensive as conventional highlighter, is without pumping or tapping operational immediately, supported in this way the sustainability concept. New liquid ink delivery system – better writing quality – greater luminance – longer writing time – ecologically superior – produced in acc. with EN-71, ASTM D-4236, liquid tank replaceable or refillable.

Price/piece 1,08 €
Quantity 1,000 pieces
Advertising code barrel S, clip T, cap T

RECYCLED PET PEN PRO SI

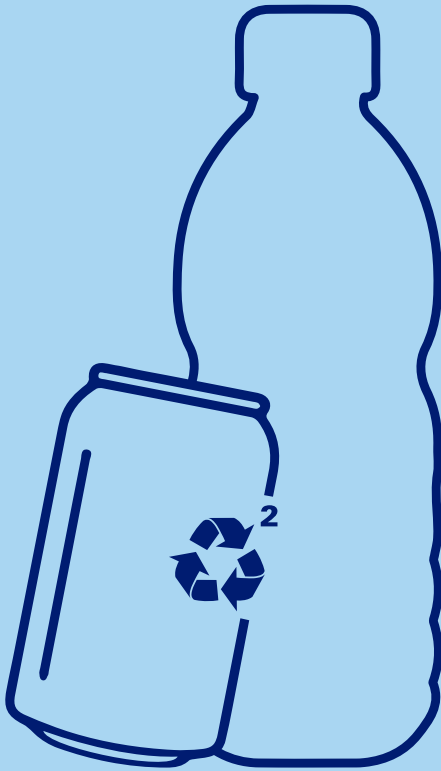

sustainable
RECYCLED²
 INNOVATIVE



Produkt-Video / product video
 RECYCLED PET PEN PRO SI

RECYCLED PET PEN PRO SI Recycled² – die nachhaltigste Kombination in einem Schreibgerät!

Recycelte PET-Getränke-Flaschen treffen auf recycelte Aluminium-Getränkedosen. Die uma rPET PRO Serie ist eine der nachhaltigsten Schreibgeräteentwicklungen der Werbebranche. Eine 100 % ClimatePartner-zertifizierte, europäische und nach Global Recycled Standard zertifizierte Produktion bilden die Basis für langlebiges und nachhaltiges Schreiben. Die neue Upcycling-Idee erweitert die bisher reine recycelte PET-Schreibgeräteserie um schicke Metallapplikationen. Aus einer recycelten Aluminium 150 ml Getränkedose entstehen 10 wertige Metallspitzen, die auf ein PET-Gehäuse einer recycelten 0,5 l PET-Flasche treffen. So schreiben Sie mit dem uma RECYCLED PET PEN PRO SI die nachhaltigste Kombination für die Umwelt – eben: uma Recycled².

RECYCLED PET PEN PRO SI Recycled² – the most sustainable combination in a writing instrument!

Recycled PET beverage bottles meet recycled aluminium beverage cans. The uma rPET PRO series is one of the most sustainable writing instrument developments in the promotional industry. A ClimatePartner-certified, European and Global Recycled Standard certified production built up the basics for long-lasting and sustainable writing. The new upcycling idea adds elegant metal applications to the previously pure recycled PET writing instrument series. A recycled aluminium 150ml beverage can is recycled into 10 valuable metal tips that meet a PET housing of a recycled 0.5 l PET bottle. So with the uma RECYCLED PET PEN PRO SI you write the most sustainable combination for the environment – just: uma Recycled².



0-2250 F-SI, 0-2250 TF-SI

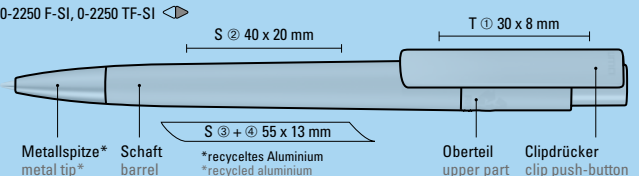

Farb-Code/Minen
Colour code/Refills

RECYCLED PET PEN PRO F-SI
0-2250 F-SI

RECYCLED PET PEN PRO frozen SI
0-2250 TF-SI

0-2250 F-SI (● 8-0855)



57-0002



57-0001



● 8-0855

0-2250 TF-SI (● 8-0856)



57-0286



57-0185



57-0355



57-0440



57-0291



57-0107



57-0260



57-0226



57-0151



57-3295



● 8-0856



Aufgrund der Besonderheiten des Materials (recyceltes PET-Material) sind produktions-technische Farbschwankungen gegeben.

Due to the special nature of the material (recycled PET material) production-related variations are possible.

Die Gewinnung und Verarbeitung des rPET-Materials aus 100% recycelten PET-Flaschen sowie das rAL-Material aus 100% recycelten Aluminium-Getränkedosen findet in Europa statt. Die beiden Materialien eignen sich für einen langlebigen und nachhaltigen Werbeeinsatz. Dank der europäischen und ClimatePartner-zertifizierten Produktion leisten der uma RECYCLED PET PEN PRO einen zusätzlichen nachhaltigen Beitrag zur Schonung der Umwelt.

The extraction and processing of the rPET material from 100% recycled PET bottles, as well as the rAL material from 100% recycled aluminium beverage cans takes place in Europe. Both materials are suitable for a durable and sustainable advertisement. Thanks to the European and ClimatePartner-certified production, the uma RECYCLED PET PEN PRO make an additional sustainable contribution to the protection of the environment.



Mix n' Match: Ab 2.000 Stück kann das Modell farblich kombiniert werden.

0-2250 F-SI: Druckkugelschreiber aus recyceltem PET-Material mit matt gedecktem Gehäuse und Clip sowie Metallspitze aus recyceltem Aluminium in silber matt.

0-2250 TF-SI: Druckkugelschreiber aus recyceltem PET-Material mit transparent gefrostetem Gehäuse und Clip sowie Metallspitze aus recyceltem Aluminium in silber matt.

Preis/Stück 0-2250 F-SI	0,88 €
Preis/Stück 0-2250 TF-SI	0,88 €
Menge	1.000 Stück
Werbeschlüssel	Schaft S, Clip T

Mix n' Match: From 2,000 pieces, you can choose any colour combination.

0-2250 F-SI: Retractable ballpoint pen made from recycled PET material with opaque matt housing and clip, metal tip made from recycled aluminium in matt silver.

0-2250 TF-SI: Retractable ballpoint pen made from recycled PET material with transparent frosted housing and clip, metal tip made from recycled aluminium in matt silver.

Price/piece 0-2250 F-SI	0.88 €
Price/piece 0-2250 TF-SI	0.88 €
Quantity	1,000 pieces
Advertising code	barrel S, clip T

RECYCLED PET PEN PRO

ocean



made from ocean-bound plastic



Produkt-Video/
product video

0-2250 F OCEAN ◀

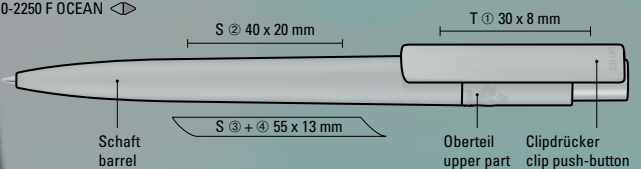

Farb-Code/Minen
Colour code/Refills

RECYCLED PET PEN PRO F ocean
0-2250 F OCEAN

0-2250 F OCEAN (● 8-0854)



Aufgrund der Besonderheiten des Materials (recyceltes PET-Material) sind produktionstechnische Farbschwankungen gegeben.

Due to the special nature of the material (recycled PET material) production-related variations are possible.



Etui Empfehlung/Case suggestion
ETUI 0-0940 CI OCEAN
Informationen unter www.uma-pen.com
Information at www.uma-pen.com

Das durch Plastic Bank gesammelte Ocean Bound Plastic, auch bekannt als Social Plastic®, wird in Europa zu einem recycelten PET Schreibgerät für einen langlebigen und nachhaltigen Werbeeinsatz upgecycelt. Dank der europäischen und ClimatePartner-zertifizierten Produktion leistet der uma RECYCLED PET PEN PRO F ocean einen zusätzlichen nachhaltigen Beitrag zur Schonung der Umwelt.

Ocean-bound plastic, also known as Social Plastic®, collected through Plastic Bank is upcycled in Europe into a recycled PET writing instrument for long-lasting and sustainable advertisement. Thanks to the European and ClimatePartner-certified production, the uma RECYCLED PET PEN PRO F ocean makes an additional sustainable contribution to the protection of the environment.

Mix n' Match: Ab 2.000 Stück kann das Modell farblich kombiniert werden.

0-2250 F OCEAN: Druckkugelschreiber aus recyceltem PET-Material aus Ocean Bound Plastic mit matt gedecktem Gehäuse und Clip.

Preis/Stück
Menge
Werbeschlüssel

0,73 €
1.000 Stück
Schaft S, Clip T

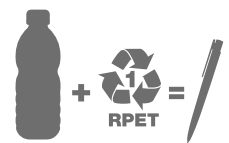

made from ocean-bound plastic

Mix n' Match: From 2,000 pieces, you can choose any colour combination.

0-2250 F OCEAN: Retractable ballpoint pen made from ocean-bound PET material with opaque matt housing and clip.

Price/piece
Quantity
Advertising code

0.73 €
1,000 pieces
barrel S, clip T



0-2250 ANTIBAC ◀

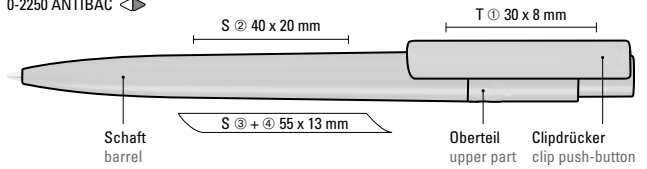

0-2250 ANTIBAC (● 8-0854)



Hinweis auf dem Schaft aufgedruckt:
„antibacterial“ und „antiviral“
Note printed on the barrel
„antibacterial“ and „antiviral“





 **Wirkt gegen
Corona - Viren**

Das aus recycelten PET-Flaschen in Europa hergestellte rPET-Material eignet sich für langlebigen und nachhaltigen Werbeeinsatz. Der uma RECYCLED PET PEN PRO antibacterial bietet gleichzeitig mehrere Verkaufsargumente: recycelt, umweltverträglich, ClimatePartner-zertifiziert, antibakteriell und antiviral. Aufgrund der Besonderheiten des Materials (recyceltes PET-Material) sind produktionstechnische Farbschwankungen gegeben.

The rPET material, which is produced in Europe from recycled PET bottles, is suitable for a durable and sustainable advertisement. The uma RECYCLED PET PEN PRO antibacterial offers several sales arguments: recycled, environmentally friendly, ClimatePartner-certified, antibacterial and antiviral. Due to the special nature of the material (recycled PET material) production-related variations are possible.

ANTIBAKTERIELL 

ANTIVIRAL 

RECYCLET 

KLIMAOPTIMIERT 



Mix n' Match: Ab 2.000 Stück kann das Modell farblich kombiniert werden.

0-2250 ANTIBAC: Druckkugelschreiber aus recyceltem, antibakteriellem und antiviralem rPET in gedecktem glänzendem Gehäuse und Clip. Der nach ISO 22196 und ISO 21702 geprüfte antimikrobielle Zusatz verleiht dem rPET eine antibakterielle und antivirale Wirkung auch gegen Corona-Viren. Die Haftung und Ansiedlung von Bakterien oder Krankheitserregern auf der Oberfläche des Schreibgerätes wird um 99,99% verringert. Der in das rPET Material eingearbeitete antimikrobielle Zusatz kann nicht abgerieben oder abgegeben werden und wirkt über die gesamte Lebensdauer des Schreibgerätes. Eine dauerhafte Reduzierung von Krankheitserregern ist gegeben.

Preis/Stück 0,63 €
Menge 1.000 Stück
Werbeschlüssel Schaft S, Clip T

Mix n' Match: From 2,000 pieces, you can choose any colour combination.

0-2250 ANTIBAC: Retractable ballpoint pen made from recycled, antibacterial and antiviral recycled PET material with opaque glossy housing and clip. The ISO 22196 and ISO 21702 tested antimicrobial additive of silver ions gives the rPET material an antibacterial and antiviral effect that reduces the adhesion and settling of bacteria or pathogens on the surface of the writing instrument by 99.99%. The antimicrobial additive incorporated into the rPET material cannot be rubbed off or released and is effective over the entire life of the writing instrument. A permanent reduction of pathogens is given.

Price/piece 0.63 €
Quantity 1,000 pieces
Advertising code barrel S, clip T



0-2250 F TO ◊

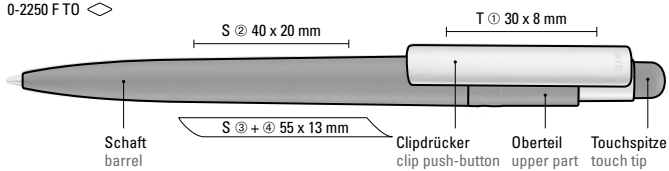

Farb-Code/Minen
Colour code/Refills

RECYCLED PET PEN PRO F TOUCH
0-2250 F TO

0-2250 F TO (● 8-0854)



Aufgrund der Besonderheiten des Materials (recyceltes PET-Material) sind produktionstechnische Farbschwankungen gegeben.

Due to the special nature of the material (recycled PET material) production-related variations are possible.



Das aus recycelten PET-Flaschen in Europa hergestellte rPET-Material eignet sich für einen langlebigen und nachhaltigen Werbeeinsatz. Dank der europäischen und ClimatePartner-zertifizierten Produktion leistet der uma RECYCLED PET PEN PRO F TOUCH einen zusätzlichen nachhaltigen Beitrag zur Schonung der Umwelt.

The rPET material, which is produced in Europe from recycled PET bottles, is suitable for a durable and sustainable advertisement. Thanks to the European and ClimatePartner-certified production, the uma RECYCLED PET PEN PRO F TOUCH makes an additional sustainable contribution to the protection of the environment.



0-2250 F TO: Druckkugelschreiber aus recyceltem PET-Material mit matt gedecktem Gehäuse und silbernem Clip, Drücker mit integrierter Touchscreensteuerung.

Preis/Stück
Menge
Werbeschlüssel

0,93 €
1.000 Stück
Schaft S, Clip T

0-2250 F TO: Retractable ballpoint pen made from recycled PET material with opaque matt housing and silver clip, push-button with integrated touch screen control.

Price/piece
Quantity
Advertising code

0.93 €
1,000 pieces
barrel S, clip T



RECYCLED PET PEN ALUMA



Die Gewinnung und Verarbeitung des rPET Materials aus 100% recycelten PET-Flaschen sowie das rAL-Material aus 100% recycelten Aluminium-Getränkedosen findet in Europa statt. Die beiden Materialien eignen sich für einen langlebigen und nachhaltigen Werbeeinsatz. Dank der europäischen und ClimatePartner-zertifizierten Produktion leistet der uma RECYCLED PET PEN ALUMA einen zusätzlichen nachhaltigen Beitrag zur Schonung der Umwelt.

Aufgrund der Besonderheiten des Materials (recyceltes PET-Material) sind produktionstechnische Farbschwankungen gegeben.

The extraction and processing of the rPET material from 100% recycled PET bottles, as well as the rAL material from 100% recycled aluminium beverage cans takes place in Europe. Both materials are suitable for a durable and sustainable advertisement. Thanks to the European and ClimatePartner-certified production, the uma RECYCLED PET PEN ALUMA makes an additional sustainable contribution to the protection of the environment.

Due to the special nature of the material (recycled PET material) production-related variations are possible.



Etui Empfehlung/ Case suggestion
 ETUI 0-0940 CI ALUMA
 Informationen unter www.uma-pen.com
 Information at www.uma-pen.com

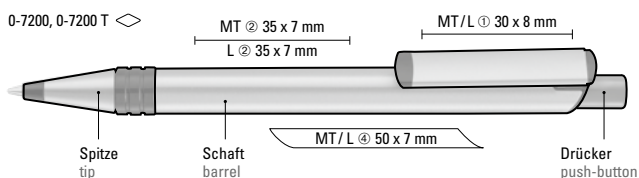

Farb-Code/Minen
Colour code/Refills

RECYCLED PET PEN ALUMA
0-7200

RECYCLED PET PEN PRO ALUMA transparent
0-7200 T

0-7200 (● 8-0855)
0-7200 T (● 8-0856)



Die Modelle eignen sich für eine
Lasergravur in weiß.

The Models are suitable for
laser engraving in white.



0-7200: Metall-Druckkugelschreiber mit Metallspitze,
Metallschaft und Metallclip aus recyceltem Aluminium,
Kunststoffteile aus recyceltem PET-Material in gedeckt schwarz
und gedeckt farbigem Drücker.

0-7200 T: Metall-Druckkugelschreiber mit Metallspitze,
Metallschaft und Metallclip aus recyceltem Aluminium,
Kunststoffteile aus recyceltem PET-Material in klar transparent
und gedeckt farbigem Drücker.

Preis/Stück 0-7200	1,51 €
Preis/Stück 0-7200 T	1,51 €
Menge	300 Stück
Werbeschlüssel	Schaft MT/L, Clip MT/L

0-7200: Metal retractable ballpoint pen with metal tip, metal
barrel and metal clip made from recycled aluminium in matt
silver, plastic parts made from recycled PET material in opaque
glossy black and opaque coloured push-button.

0-7200 T: Metal retractable ballpoint pen with metal tip, metal
barrel and metal clip made from recycled aluminium in matt
silver, plastic parts made from recycled PET material in opaque
clear transparent and opaque coloured push-button.

Price/piece 0-7200	1.51 €
Price/piece 0-7200 T	1.51 €
Quantity	300 pieces
Advertising code	barrel MT/L, clip MT/L



0-2260 ◀▶, 0-2260 T ◀▶, 0-2260 T SG ◀▶

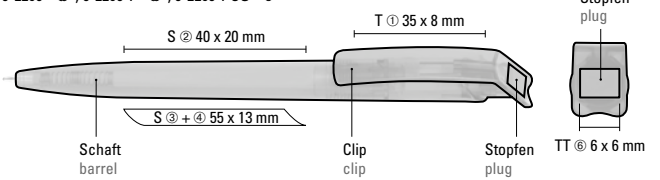

Farb-Code/Minen
Colour code/Refills

RECYCLED
PET PEN
0-2260

RECYCLED
PET PEN transparent
0-2260 T

RECYCLED
PET PEN transparent SG
0-2260 T SG

0-2260 (● 8-0866)	0-2260 T (● 8-0866)
0-2260 T SG (● 8-0866)	
 57-0298	 57-0286
 57-0662	 57-0185
 57-0200	 57-0355
 57-7492	 57-0440
 57-0361	 57-0107
 57-0340	 57-0260
 57-0002	 57-0226
 57-7527	 57-0151
 57-0001	 57-3295
 57-0012	 57-0866
 57-0270	
 57-2607	
 57-0233	
 57-0021	
 57-7710	
 57-7500	
 57-0866	

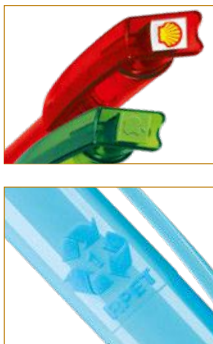

Das aus recycelten PET-Flaschen in Europa hergestellte rPET-Material eignet sich für einen langlebigen und nachhaltigen Werbeeinsatz. Dank der europäischen und ClimatePartner-zertifizierten Produktion leistet der uma RECYCLED PET PEN einen zusätzlichen nachhaltigen Beitrag zur Schonung der Umwelt.

Aufgrund der Besonderheiten des Materials (recyceltes PET-Material) sind produktionstechnische Farbschwankungen gegeben.

The rPET material, which is produced in Europe from recycled PET bottles, is suitable for a durable and sustainable advertisement. Thanks to the European and ClimatePartner-certified production, the uma RECYCLED PET PEN makes an additional sustainable contribution to the protection of the environment.

Due to the special nature of the material (recycled PET material) production-related variations are possible.



ClimatePartner
zertifiziertes Produkt
climate-id.com/DIPVA4



Mix n' Match: Ab 2.000 Stück kann das Modell farblich kombiniert werden.

0-2260: Druckkugelschreiber aus recyceltem rPET-Material mit gedeckt glänzendem Gehäuse und Stopfen.

0-2260 T: Druckkugelschreiber aus recyceltem rPET-Material mit transparent glänzendem Gehäuse und gedecktem Stopfen.

0-2260 T SG: Druckkugelschreiber aus recyceltem rPET-Material mit klar transparent glänzendem Gehäuse und gedecktem Stopfen.

Preis/Stück 0-2260	0,61 €
Preis/Stück 0-2260 T	0,61 €
Preis/Stück 0-2260 T SG	0,61 €
Menge	1.000 Stück
Werbeschlüssel	Schaft S, Clip T, Stopfen TT

Mix n' Match: From 2,000 pieces, you can choose any colour combination.

0-2260: Retractable ballpoint pen made from recycled PET material with opaque glossy housing and plug.

0-2260 T: Retractable ballpoint pen made from recycled PET material with transparent housing and opaque glossy plug.

0-2260 T SG: Retractable ballpoint pen made from recycled PET material with clear transparent housing and opaque glossy plug.

Price/piece 0-2260	0.61 €
Price/piece 0-2260 T	0.61 €
Price/piece 0-2260 T SG	0.61 €
Quantity	1,000 pieces
Advertising code	barrel S, clip T, plug TT



0-2240 T (● 8-0866)

- 57-0286
- 57-0185
- 57-0355
- 57-0440
- 57-0291
- 57-0107
- 57-0260
- 57-0226
- 57-0151
- 57-3295

● 8-0866

Das aus recycelten PET-Flaschen in Europa hergestellte rPET-Material eignet sich für einen langlebigen und nachhaltigen Werbeeinsatz. Dank der europäischen und ClimatePartner-zertifizierten Produktion leistet der uma RECYCLED PET PEN switch einen zusätzlichen nachhaltigen Beitrag zur Schonung der Umwelt.

The rPET material, which is produced in Europe from recycled PET bottles, is suitable for a durable and sustainable advertisement. Thanks to the European and ClimatePartner-certified production, the uma RECYCLED PET PEN switch makes an additional sustainable contribution to the protection of the environment.

0-2240 T ◊

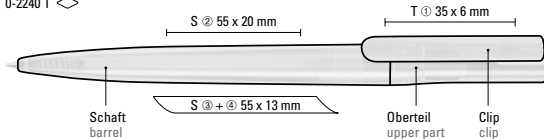

0-2240 T: Drehkugelschreiber aus recyceltem rPET-Material mit transparent glänzendem Gehäuse.

Preis/Stück 0,61 €
Menge 1.000 Stück
Werbeschlüssel Schaft S, Clip T

0-2240 T: Twist ballpoint pen made from recycled PET material with transparent glossy housing.

Price/piece 0.61 €
Quantity 1,000 pieces
Advertising code barrel S, clip T

Farb-Code/Minen
Colour code/Refills

RECYCLED PET PEN switch
0-2240

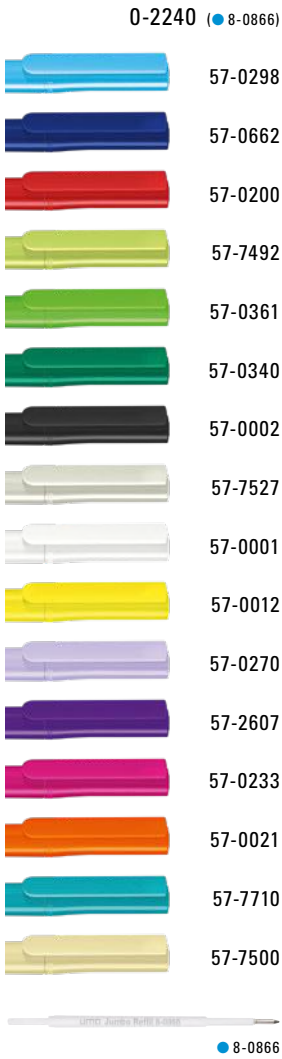

Aufgrund der Besonderheiten des Materials (recyceltes PET-Material) sind produktionstechnische Farbschwankungen gegeben.

Due to the special nature of the material (recycled PET material) production-related variations are possible.

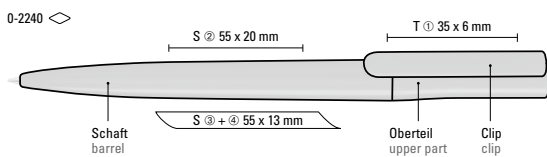

0-2240: Drehkugelschreiber aus recyceltem rPET-Material mit gedeckt glänzendem Gehäuse.

Preis/Stück
Menge
Werbeschlüssel

0,61 €
1.000 Stück
Schaft S, Clip T

0-2240: Twist ballpoint pen made from recycled PET material with opaque glossy housing.

Price/piece
Quantity
Advertising code

0.61 €
1,000 pieces
barrel S, clip T



RECY-Modelle / RECY models

Das Gehäuse des HAPPY RECY wird aus recyceltem ABS-Kunststoff hergestellt und ist mit dem rABS-Logo gekennzeichnet.

The housing of the HAPPY RECY is made of recycled plastics (ABS) and is marked with the rABS logo.

HAPPY RECY
0-0037 RECY



rABS – recycelter Kunststoff /
rABS – recycled plastic

Recycelter ABS-Kunststoff wird aus industriellen **Spritzgussresten** hergestellt. Hierzu werden die Kunststoffabfälle gesammelt und dem Spritzgussprozess wieder zugeführt. Die gesammelten Kunststoffe können sortenrein und qualitätsbestimmt gesammelt werden. Durch das Aufbereiten der Kunststoffe kann aus diesen ein recyceltes Produkt gefertigt werden. Generell wird durch das Recyceln der Kunststoffe weniger Rohöl und Energie verbraucht.

Recycled ABS plastic is made from industrial **injection moulding offcuts**. For this, plastic waste is collected up and directed back into the injection moulding process. The collected plastics can be collected, graded and grouped by quality standard. These preparatory operations with plastics are the key to manufacturing a recycled product. Without exception, the recycling of plastics uses less crude oil and power.



RECY-Modelle / RECY models



**POST-CONSUMER
RECYCLED PLASTIC**

**rPCP – recycler Kunststoff /
rPCP – recycled plastic**

Recycelter Post-Consumer-Kunststoff (PCP) wird meist aus technischen (Haushalts-) Geräten oder sonstigen **Consumer Kunststoffabfällen** gewonnen. Hierzu werden die Kunststoffe gesammelt und sortenrein recycelt. Die sogenannten Post Consumer oder Post Industry Kunststoffe können nach der Aufbereitung in ein neues Produkt upgecyclt werden. Generell wird durch das Recyclen der Kunststoffe weniger Rohöl und Energie verbraucht.

For the most part, recycled post-consumer plastic (PCP) is obtained from technical (domestic) appliances or other forms of **plastic consumer waste**. This process involves collecting and grading plastics and recycling each grade separately. After the recycling process, a new product can be ‚upcycled‘ from what are known as post-consumer or also post industry plastics. Without exception, the recycling of plastics uses less crude oil and power.



Das Gehäuse des
ICONIC RECY wird
aus recyceltem
Post-Consumer-
Kunststoff (PCP)
hergestellt und
ist mit dem POST-
CONSUMER-
RECYCLED-
PLASTIC-Logo
gekennzeichnet.

The housing of the
ICONIC RECY is
made of recycled
Post-Consumer
plastics (PCP) and
is marked with the
POST-CONSUMER
RECYCLED
PLASTIC logo.

ICONIC RECY
0-0057 RECY



0-0133 RECY, 0-0133 SI RECY* ◇

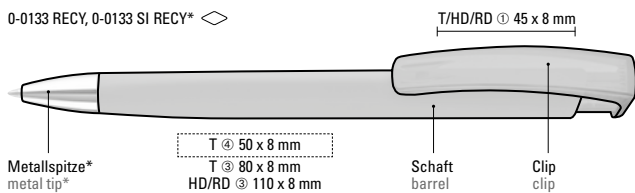

Farb-Code/Minen
Colour code/Refills

TRINITY RECY
0-0133 RECY

TRINITY SI RECY
0-0133 SI RECY

0-0133 RECY (● 8-0855)
0-0133 SI RECY (● 8-0855)



Etui Empfehlung/Case suggestion
ETUI 0-0933 CI
Informationen unter www.uma-pen.com
Information at www.uma-pen.com

Aufgrund der Besonderheit des Materials (ABS Recycled Plastic) sind produktionstechnische Farbschwankungen gegeben.

Due to the special nature of the material (ABS recycled plastic) production-related variations are possible.



Das Modell ist mit dem Recyclingzeichen gekennzeichnet. Dank der europäischen und ClimatePartner-zertifizierten Produktion leistet der uma TRINITY RECY einen zusätzlichen nachhaltigen Beitrag zur Schonung der Umwelt.

The model is labelled with the recycling mark. Thanks to the European and ClimatePartner-certified production, the uma TRINITY RECY makes an additional sustainable contribution to the protection of the environment.



0-0133 RECY: Druckkugelschreiber mit gedeckt mattem Dreikantgehäuse und glänzendem Clip aus recyceltem ABS-Kunststoff.

0-0133 SI RECY: Druckkugelschreiber mit gedeckt mattem Dreikantgehäuse und glänzendem Clip aus recyceltem ABS-Kunststoff, schwere Metallspitze glanzverchromt.

Preis/Stück 0-0133 RECY	0,58 €
Preis/Stück 0-0133 SI RECY	0,72 €
Menge	1.000 Stück
Werbeschlüssel	Schaft T/HD/RD, Clip T/HD/RD

0-0133 RECY: Retractable ballpoint pen with opaque matt triangular housing and glossy clip made from recycled ABS plastic.

0-0133 SI RECY: Retractable ballpoint pen with opaque matt triangular housing and glossy clip made from recycled ABS plastic and heavy metal tip chrome plated.

Price/piece 0-0133 RECY	0.58 €
Price/piece 0-0133 SI RECY	0.72 €
Quantity	1,000 pieces
Advertising code	barrel T/HD/RD, clip T/HD/RD



0-0133 KT RECY, 0-0133 KT-SI RECY* ◇

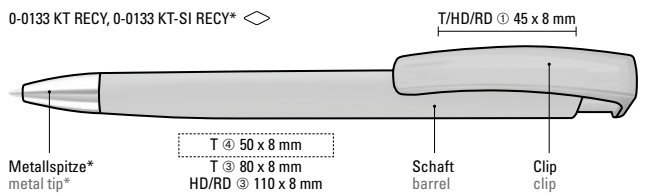

Farb-Code/Minen
Colour code/Refills

TRINITY K transparent RECY
0-0133 KT RECY

TRINITY K transparent SI RECY
0-0133 KT-SI RECY

0-0133 KT RECY (● 8-0855)
0-0133 KT-SI RECY (● 8-0855)



Aufgrund der Besonderheit des Materials (ABS Recycled Plastic) sind produktionstechnische Farbschwankungen gegeben.

Due to the special nature of the material (ABS recycled plastic) production-related variations are possible.



Das Modell ist mit dem Recyclingzeichen gekennzeichnet. Dank der europäischen und ClimatePartner-zertifizierten Produktion leistet der uma TRINITY RECY einen zusätzlichen nachhaltigen Beitrag zur Schonung der Umwelt.

The model is labelled with the recycling mark. Thanks to the European and ClimatePartner-certified production, the uma TRINITY RECY makes an additional sustainable contribution to the protection of the environment.



0-0133 KT RECY: Druckkugelschreiber mit gedeckt mattem Dreikantgehäuse und transparent glänzendem Clip aus recyceltem ABS-Kunststoff.

0-0133 KT-SI RECY: Druckkugelschreiber mit gedeckt mattem Dreikantgehäuse, transparent glänzendem Clip aus recyceltem ABS-Kunststoff und schwerer Metallspitze glanzverchromt.

Preis/Stück 0-0133 KT RECY	0,58 €
Preis/Stück 0-0133 KT-SI RECY	0,72 €
Menge	1.000 Stück
Werbeschlüssel	Schaft T/HD/RD, Clip T/HD/RD

0-0133 KT RECY: Retractable ballpoint pen with opaque matt triangular housing and transparent glossy clip made from recycled ABS plastic.

0-0133 KT-SI RECY: Retractable ballpoint pen with opaque matt triangular housing, transparent glossy clip made from recycled ABS plastic and heavy metal tip chrome plated.

Price/piece 0-0133 KT RECY	0.58 €
Price/piece 0-0133 KT-SI RECY	0.72 €
Quantity	1,000 pieces
Advertising code	barrel T/HD/RD, clip T/HD/RD

YES RECY
0-0092 RECY

HAPPY RECY
0-0037 RECY

Farb-Code/Minen
Colour code/Refills



0-0092 RECY (● 8-0854)

50-0301 

50-0340 

50-0002 

50-CG08 

50-0001 

● 8-0854

0-0037 RECY (● 8-0865)

01-0002 

01-CG08 

01-0001 



● 8-0865



Das Modell ist mit dem Recyclingzeichen gekennzeichnet. Dank der ClimatePartner-zertifizierten Produktion leisten der uma YES RECY und HAPPY RECY einen zusätzlichen nachhaltigen Beitrag zur Schonung der Umwelt. Aufgrund der Besonderheit des Materials (ABS Recycled Plastic) sind produktionstechnische Farbschwankungen gegeben.

The models are labelled with the recycling mark. Thanks to the ClimatePartner-certified production, the uma YES RECY and HAPPY RECY make an additional sustainable contribution to the protection of the environment.

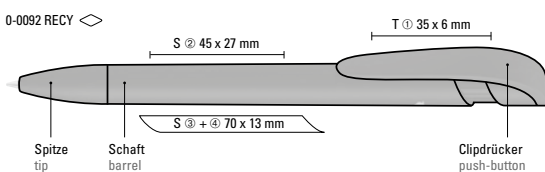
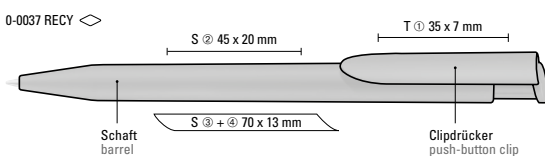
Due to the special nature of the material (ABS recycled plastic) production-related variations are possible.



0-0092 RECY: Druckkugelschreiber mit gedeckt mattem Gehäuse, breitem Bogenclipdrücker und Spitze aus recyceltem Kunststoff.

0-0037 RECY: Druckkugelschreiber mit gedeckt mattem Gehäuse und Clipdrücker aus recyceltem Kunststoff.

Preis/Stück 0-0092 RECY	0,43 €
Preis/Stück 0-0037 RECY	0,29 €
Menge	1.000 Stück
Werbeschlüssel	Schaft S, Clip T

0-0092 RECY: Retractable ballpoint pen with opaque matt housing, wide curved clip button and tip made from recycled plastic.

0-0037 RECY: Retractable ballpoint pen with opaque matt housing and clip button made of recycled plastic.

Price/piece 0-0092 RECY	0.43 €
Price/piece 0-0037 RECY	0.29 €
Quantity	1,000 pieces
Advertising code	barrel S, clip T

1-0736 RECY (● 8-0877)



Das Modell ist mit dem Recyclingzeichen gekennzeichnet. Dank der ClimatePartner-zertifizierten Produktion leistet der uma VITAN RECY einen zusätzlichen nachhaltigen Beitrag zur Schonung der Umwelt. Aufgrund der Besonderheit des Materials (ABS Recycled Plastic) sind produktionstechnische Farbschwankungen gegeben.

The model is labelled with the recycling mark. Thanks to the ClimatePartner-certified production, the uma VITAN RECY makes an additional sustainable contribution to the protection of the environment. Due to the special nature of the material (ABS recycled plastic) production-related variations are possible.

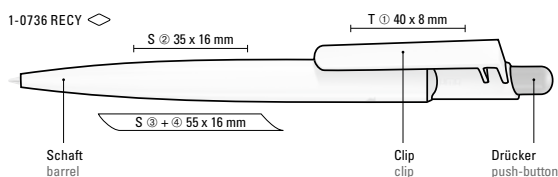

1-0736 RECY: Druckkugelschreiber mit gedeckt glänzendem Gehäuse aus 100% recyceltem Kunststoff und großem Clip an verstärkter Clipanbindung.

Preis/Stück
Menge
Werbeschlüssel

0,53 €
1.000 Stück
Schaft S ⊕, Clip T

1-0736 RECY: Retractable ballpoint pen with opaque glossy body and large clip made from 100% recycled plastic.

Price/piece
Quantity
Advertising code

0,53 €
1,000 pieces
barrel S ⊕, clip T



0-0063 F RECY (● 8-0866)

- 32-0292
- 32-2175
- 32-0200
- 32-0382
- 32-0348
- 32-0002
- 32-0001
- 32-0115
- 32-2685
- 32-0213
- 32-1585
- 32-3262
- 8-0866

Das Modell ist mit dem Recyclingzeichen gekennzeichnet. Dank der europäischen und ClimatePartner-zertifizierten Produktion leistet der uma ON TOP F RECY einen zusätzlichen nachhaltigen Beitrag zur Schonung der Umwelt. Aufgrund der Besonderheit des Materials (ABS Recycled Plastic) sind produktionstechnische Farbschwankungen gegeben.

The model is labelled with the recycling mark. Thanks to the European and ClimatePartner-certified production, the uma ON TOP F RECY makes an additional sustainable contribution to the protection of the environment. Due to the special nature of the material (ABS recycled plastic) production-related variations are possible.

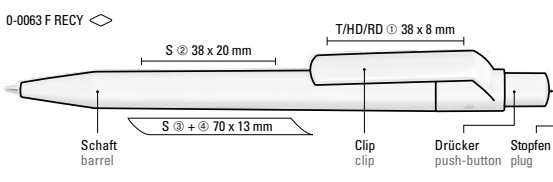

0-0063 F RECY: Druckkugelschreiber mit gedeckt mattem Gehäuse, Clip, Drücker und Stopfen aus recyceltem ABS-Kunststoff.

Preis/Stück 0,71 €
Menge 1.000 Stück
Werbeschlüssel Schaft S ○, Clip T/HD/RD

0-0063 F RECY: Retractable ballpoint pen with opaque matt housing, clip, push-button and plug made from recycled ABS plastic.

Price/piece 0.71 €
Quantity 1,000 pieces
Advertising code barrel S ○, clip T/HD/RD

Farb-Code/Minen
Colour code/Refills

ON TOP RECY
0-0063 RECY

0-0063 RECY (● 8-0866)



Drücker/Stopfen ABS
push-button/plug ABS

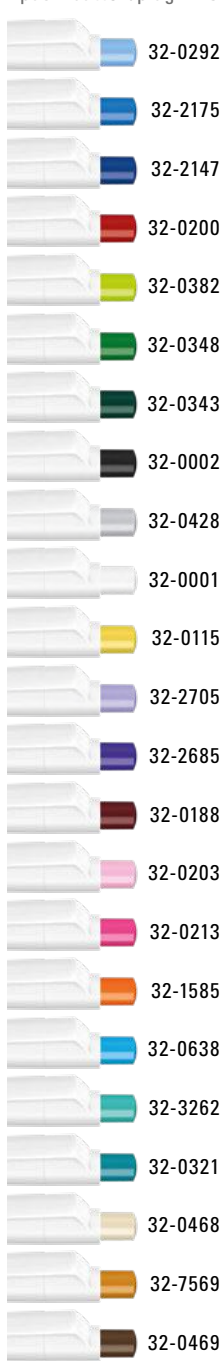

0-0063 RECY:
Drücker und Stopfen sind
ab 2.000 Stück auch in
allen glänzend gedeckten
ABS Standardfarben
erhältlich.

0-0063 RECY:
From 2,000 units,
push-buttons and plugs
are available in all solid
shiny ABS standard
colours.

Aufgrund der Besonderheit
des Materials (Post-
Consumer Recycled
Plastic) sind
produktionstechnische
Farbschwankungen
gegeben.

Due to the special nature
of the material (post-
consumer recycled plastic)
production-related
variations are possible.



Das Modell ist mit dem Recyclingzeichen gekennzeichnet. Dank der europäischen und ClimatePartner-zertifizierten Produktion leistet der uma ON TOP RECY einen zusätzlichen nachhaltigen Beitrag zur Schonung der Umwelt.

The model is labelled with the recycling mark. Thanks to the European and ClimatePartner-certified production, the uma ON TOP RECY makes an additional sustainable contribution to the protection of the environment.

0-0063 RECY ◀

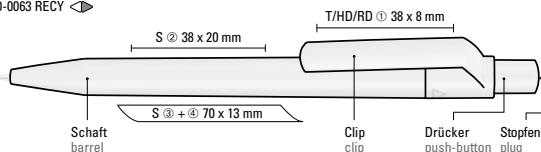

POST-CONSUMER
RECYCLED PLASTIC



ClimatePartner
zertifiziertes Produkt
climate-id.com/DIPVA4



Mix n' Match: Ab 2.000 Stück kann das Modell farblich kombiniert werden.

0-0063 RECY: Druckkugelschreiber mit gedeckt mattem Gehäuse, Clip, Drücker und Stopfen aus 100% recyceltem Post-Consumer-Kunststoff.

Preis/Stück 0,71 €
Menge 1.000 Stück
Werbeschlüssel Schaft S, Clip T/HD/RD

Mix n' Match: From 2,000 pieces, you can choose any colour combination.

0-0063 RECY: Retractable ballpoint pen with opaque matt housing, clip, push-button and plug made from 100% recycled post-consumer plastic.

Price/piece 0.71 €
Quantity 1,000 pieces
Advertising code barrel S, clip T/HD/RD

PIXEL RECY
0-0017 RECY

ICONIC RECY
0-0057 RECY

Farb-Code/Minen
Colour code/Refills



Aufgrund der Besonderheit des Materials (Post-Consumer Recycled Plastic) sind produktionstechnische Farbschwankungen gegeben.

Due to the special nature of the material (post-consumer recycled plastic) production-related variations are possible.

Drücker ABS push-button ABS	0-0017 RECY (● 8-0866)
	0-0057 RECY (● 8-0866)
32-2175	32-0534
32-2147	32-0350
32-0200	32-0432
32-0348	32-0425
32-0343	32-0428
32-0002	32-0001
32-0001	32-0466
32-0468	32-7532
32-0115	
32-1585	
32-0188	



0-0017 RECY:
Drücker sind ab 2.000 Stück auch in allen glänzend gedeckten ABS Standardfarben erhältlich.

0-0017 RECY:
From 2,000 units, plugs are available in all solid shiny ABS standard colours.



Das Modell ist mit dem Recyclingzeichen gekennzeichnet. Dank der europäischen und ClimatePartner-zertifizierten Produktion leisten der uma PIXEL RECY und ICONIC RECY einen zusätzlichen nachhaltigen Beitrag zur Schonung der Umwelt.

The model is labelled with the recycling mark. Thanks to the European and ClimatePartner-certified production, the uma PIXEL RECY and ICONIC RECY make an additional sustainable contribution to the protection of the environment.

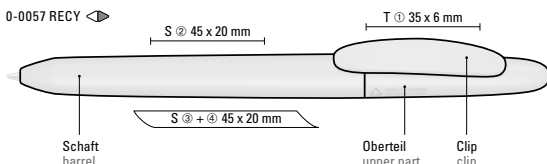
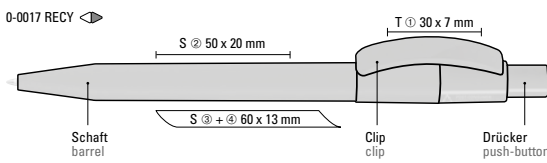

Mix'n Match: Ab 2.000 Stück kann das Modell farblich kombiniert werden.

0-0017 RECY: Druckkugelschreiber mit gedeckt mattem Kunststoffgehäuse aus 100 % recyceltem Post-Consumer-Kunststoff, glänzendem Bogenclip und Drücker.

0-0057 RECY: Drehkugelschreiber mit gedeckt mattem Gehäuse aus 100% recyceltem Post-Consumer-Kunststoff.

Preis/Stück 0-0017 RECY 0,49 €
Preis/Stück 0-0057 RECY 0,81 €
Menge 1.000 Stück
Werbeschlüssel Schaft S, Clip T

Mix'n Match: From 2,000 pieces, you can choose any colour combination.

0-0017 RECY: Retractable ballpoint pen with matt plastic housing made from 100 % recycled post-consumer plastic, opaque glossy curved clip and push-button.

0-0057 RECY: Twist ballpoint pen with opaque matt housing made from 100% recycled post-consumer plastic.

Price/piece 0-0017 RECY 0.49 €
Price/piece 0-0057 RECY 0.81 €
Quantity 1,000 pieces
Advertising code Schaft S, Clip T

Farb-Code/Minen
Colour code/Refills

VANE RECY
0-0183 RECY

POP RECY
0-0071 RECY

0-0183 RECY (● 8-0866)
0-0071 RECY (● 8-0866)



Das Modell ist mit dem Recyclingzeichen gekennzeichnet. Dank der europäischen und ClimatePartner-zertifizierten Produktion leisten der uma VANE RECY und POP RECY einen zusätzlichen nachhaltigen Beitrag zur Schonung der Umwelt.

Aufgrund der Besonderheit des Materials (Post-Consumer Recycled Plastic) sind produktionstechnische Farbschwankungen gegeben.

The model is labelled with the recycling mark. Thanks to the European and ClimatePartner-certified production, the uma VANE RECY and POP RECY make an additional sustainable contribution to the protection of the environment. Due to the special nature of the material (post-consumer recycled plastic) production-related variations are possible.

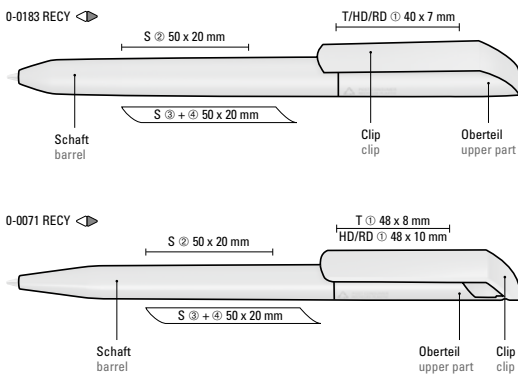

POST-CONSUMER RECYCLED PLASTIC



ClimatePartner
zertifiziertes Produkt
climate-id.com/DIPVA4



Mix'n Match: Ab 2.000 Stück kann das Modell farblich kombiniert werden.

0-0183 RECY: Drehkugelschreiber mit gedeckt mattem Gehäuse und Clip aus 100% recyceltem Post-Consumer-Kunststoff.

0-0071 RECY: Drehkugelschreiber mit gedeckt glänzendem Gehäuse aus 100% recyceltem Post-Consumer-Kunststoff.

Preis/Stück 0-0183 RECY	0,82 €
Preis/Stück 0-0071 RECY	0,65 €
Menge	1.000 Stück
Werbeschlüssel	Schaft S, Clip T/HD/RD

Mix'n Match: From 2,000 pieces, you can choose any colour combination.

0-0183 RECY: Twist ballpoint pen with opaque matt housing and clip made from 100% recycled post-consumer plastic.

0-0071 RECY: Twist ballpoint pen with opaque glossy housing made from 100% recycled post-consumer plastic.

Price/piece 0-0183 RECY	0.82 €
Price/piece 0-0071 RECY	0.65 €
Quantity	1,000 pieces
Advertising code	barrel S, clip T/HD/RD

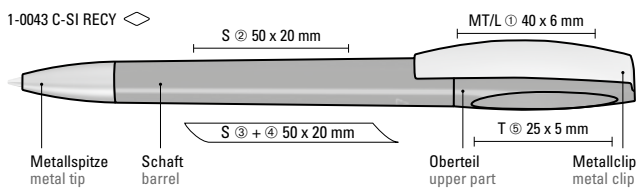
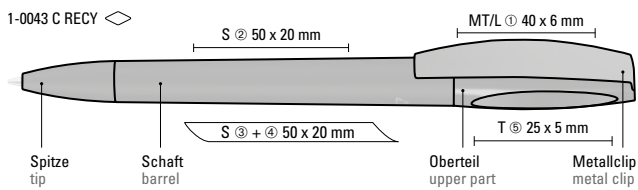

Farb-Code/Minen
Colour code/Refills

CHILL C RECY
1-0043 C RECY **new!**

CHILL C SI RECY
1-0043 C-SI RECY



umaBlackForest
Pens

Aufgrund der Besonderheit des Materials (Post-Consumer Recycled Plastic) sind produktionstechnische Farbschwankungen gegeben.
Due to the special nature of the material (post-consumer recycled plastic) production-related variations are possible.

Die Modelle sind mit dem Recyclingzeichen gekennzeichnet. Dank der ClimatePartner-zertifizierten Produktion leistet der uma CHILL RECY einen zusätzlichen nachhaltigen Beitrag zur Schonung der Umwelt.

The models are labelled with the recycling mark. Thanks to the ClimatePartner-certified production, the uma CHILL RECY makes an additional sustainable contribution to the protection of the environment.



1-0043 C RECY: Drehkugelschreiber mit gedeckt mattem Gehäuse aus 100% recyceltem Post-Consumer-Kunststoff. Metallclip matt lackiert.
1-0043 C-SI RECY: Drehkugelschreiber mit gedeckt mattem Gehäuse aus 100% recyceltem Post-Consumer-Kunststoff. Metallclip und schwere Metallspitze matt verchromt.
Preis/Stück 1-0043 C RECY 1,11 €
Preis/Stück 1-0043 C-SI RECY 1,11 €
Menge 1.000 Stück
Werbeschlüssel Schaft S O, Clip MT/L, Oberteil T

1-0043 C RECY: Twist ballpoint pen with opaque mat housing made from 100% recycled post-consumer plastic. Metal clip matt lacquered.
1-0043 C-SI RECY: Twist ballpoint pen with opaque mat housing made from 100% recycled post-consumer plastic. Metal clip and heavy metal tip matt chromed.
Price/piece 1-0043 C RECY 1.11 €
Price/piece 1-0043 C-SI RECY 1.11 €
Quantity 1,000 pieces
Advertising code barrel S O, clip MT/L, upper part T

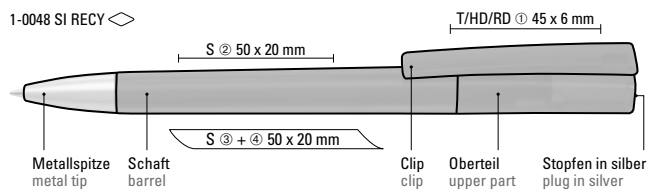
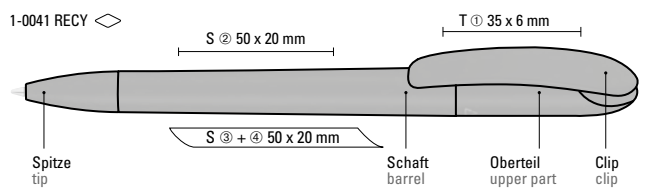

Farb-Code/Minen
Colour code/Refills

CETA RECY
1-0041 RECY

ULTIMATE SI RECY
1-0048 SI RECY

1-0041 RECY (● 8-0855)

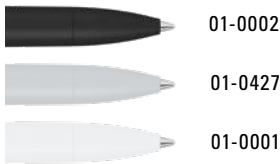

01-0002

01-0427

01-0001

1-0048 SI RECY (● 8-0855)

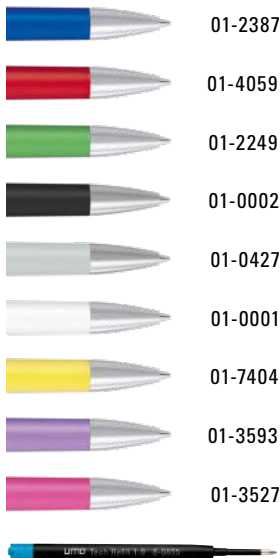

01-2387

01-4059

01-2249

01-0002

01-0427

01-0001

01-7404

01-3593

01-3527

● 8-0855

1-0048 SI,
1-0048 TF-SI,
1-0048 SI RECY
Stopfen ABS
plug ABS



01-0004

01-0284

01-0286

01-0280

01-0200

01-0375

01-0340

01-0002

01-0430

01-0001

01-0108

01-0137

01-0526

01-0219

01-0172

01-3262

Aufgrund der Besonderheit des Materials (Post-Consumer Recycled Plastic) sind produktionstechnische Farbschwankungen gegeben.

Due to the special nature of the material (post-consumer recycled plastic) production-related variations are possible.



umaBlackForest
Pens

Die Modelle sind mit dem Recyclingzeichen gekennzeichnet. Dank der ClimatePartner-zertifizierten Produktion leisten der uma CETA RECY und ULTIMATE SI RECY einen zusätzlichen nachhaltigen Beitrag zur Schonung der Umwelt.

The models are labelled with the recycling mark. Thanks to the ClimatePartner-certified production, the uma CETA RECY and ULTIMATE SI RECY makes an additional sustainable contribution to the protection of the environment.



POST-CONSUMER
RECYCLED PLASTIC



ClimatePartner
zertifiziertes Produkt
climate-id.com/DIPVA4



1-0041 RECY: Drehkugelschreiber mit gedeckt mattem Gehäuse aus 100% recyceltem Post-Consumer-Kunststoff.

1-0048 SI RECY: Drehkugelschreiber mit gedeckt mattem Gehäuse aus 100% recyceltem Post-Consumer-Kunststoff. Metallspitze matt verchromt. Stopfen optional in verschiedenen matt gedeckten Farben oder silber (Standard ABS) erhältlich.

Preis/Stück 1-0041 RECY 0,91 €
Menge 1.000 Stück
Werbeschlüssel Schaft S ○, Clip T

Preis/Stück 1-0048 SI RECY 1,06 €
Menge 1.000 Stück
Werbeschlüssel Schaft S ○, Clip T/HD/RD

1-0041 RECY: Twist ballpoint pen with opaque matt housing made from 100% recycled post-consumer plastic.

1-0048 SI RECY: Twist ballpoint pen with opaque matt housing made from 100% recycled post-consumer plastic. Metal tip matt chromed. Plugs optionally available in various matt colours or silver (standard ABS).

Price/piece 1-0041 RECY 0.91 €
Quantity 1,000 pieces
Advertising code barrel S ○, clip T

Price/piece 1-0048 SI RECY 1.06 €
Quantity 1,000 pieces
Advertising code barrel S ○, clip T/HD/RD



PEFC- und FSC®-Zertifizierung

Holz: ein ganz besonderes Material voller Wärme und natürlich gewachsener Einzigartigkeit: Jeder Kugelschreiberschaft ist ein Unikat mit eigener Geschichte. Als führender Hersteller von Werbekugelschreibern legen wir bei uma großen Wert auf Individualität. Unsere Schreibgeräte aus Holz sind dabei so einzigartig wie der Baum, aus dem sie entstanden sind.

Als Produzent aus dem Schwarzwald freut es uns, PEFC- und auch FSC®-zertifizierte Holzschreibgeräte garantieren zu können und somit zum Schutz von nachhaltigen Rohstoffen beizutragen. Für uns ist es eine Selbstverständlichkeit, an diesem Verfahren zur nachhaltigen Waldbewirtschaftung und zum Schutz eines wichtigen Rohstoffes teilzunehmen.

Die Zertifikate garantieren, dass Holz- und Papierprodukte aus nachhaltig bewirtschafteten Wäldern stammen. Mit einer Fläche von über 265 Millionen Hektar zertifizierter Waldfläche garantiert PEFC als größtes Waldzertifizierungssystem weltweit ausreichend Rohstoffmengen. Und rund 1,44 Millionen Hektar Wald sind in Deutschland FSC®-zertifiziert. Dank dieser Zertifizierungen übernehmen wir bei uma gesellschaftliche Verantwortung, denn wir unterstützen den verantwortungsbewussten Umgang mit Ressourcen und setzen uns somit für den aktiven Beitrag zum Erhalt der Wälder ein.

Für die uma Schreibgeräte aus Holz wird ausschließlich PEFC- oder FSC®-zertifiziertes Holz verwendet. Durch spezielle Bearbeitung des nachwachsenden Rohstoffs transportiert das Naturprodukt Ihre Werbebotschaft edel und formschön zum Kunden. Der Naturstoff Holz variiert sowohl in der Farbigkeit des Holzes als auch in der Struktur (Maserung).



PEFC and FSC® certification

Wood is a very special material, full of warmth and naturally grown uniqueness: every ballpoint pen barrel is unique and has its own history. As a leading manufacturer of promotional pens, we at uma attach great importance to individuality. Our wooden writing instruments are as unique as the trees they came from.

As a producer from the Black Forest, we are pleased to guarantee that our wooden writing instruments are PEFC and FSC® certified, and to contribute to the protection of sustainable raw materials in this way. It is natural for us to want to participate in this scheme for sustainable forest management and the protection of an important raw material.

These certifications guarantee that wood and paper products come from sustainably managed forests. With over 265 million hectares (655 million acres) of certified forests, PEFC is the world's largest forest certification system and guarantees sufficient quantities of raw materials. And about 1.44 million hectares German forests are FSC® certified. Thanks to this certifications, we at uma assume social responsibility by supporting responsible use of resources and being committed to making an active contribution to preserving forests.

Only PEFC or FSC® certified wood is used for the uma writing utensils made of wood. Through special processing of the sustainable raw material, the natural product transports its advertising message in a refined and beautiful design to the customer. Wood is a natural material with a great variety of colours and textures (grain effect).



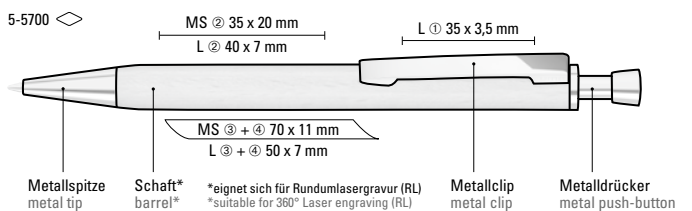

Farb-Code/Minen
Colour code/Refills

ROOT
5-5700

5-5700 (● 8-0855)



Das Modell eignet sich für eine
Lasergravur.

The model is suitable for
laser engraving.



Für diese uma Schreibgeräte aus Holz wird FSC®-zertifiziertes Buchenholz verwendet. Durch spezielle Bearbeitung des nachwachsenden Rohstoffs transportiert das Naturprodukt Ihre Werbebotschaft edel und formschön zum Kunden. Der Naturstoff Holz variiert sowohl in der Farbigkeit des Holzes als auch in der Struktur (Maserung).

Only FSC® certified beechwood is used for these uma writing utensils made of wood. Through special processing of the sustainable raw material, the natural product transports its advertising message in a refined and beautiful design to the customer.

Wood is a natural material with a great variety of colours and textures (grain effect).

Dank der ClimatePartner-zertifizierten Produktion leistet der uma ROOT einen zusätzlichen nachhaltigen Beitrag zur Schonung der Umwelt.

Thanks to the ClimatePartner-certified production, the uma ROOT makes an additional sustainable contribution to the protection of the environment.



ClimatePartner
zertifiziertes Produkt
climate-id.com/DIPVA4



5-5700: Holz-Druckkugelschreiber mit Metalldrücker, Metallclip und Metallspitze glanzverchromt. Schaft aus schutzlackiertem FSC®-zertifiziertem Buchenholz.

Preis/Stück 2,36 €
Menge 300 Stück
Werbeschlüssel Schaft MS/L/RL, Clip L

5-5700: Wooden retractable ballpoint pen with metal push-button, metal clip and metal tip chrome plated. Barrel made from FSC® certified beechwood with protective varnish coating.

Price/piece 2.36 €
Quantity 300 pieces
Advertising code barrel MS/L/RL, clip L

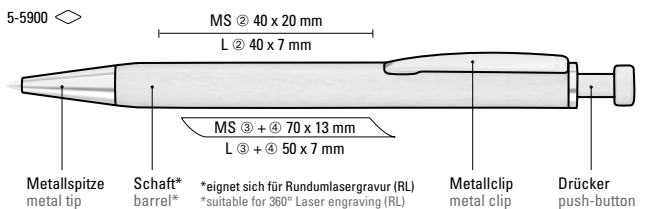
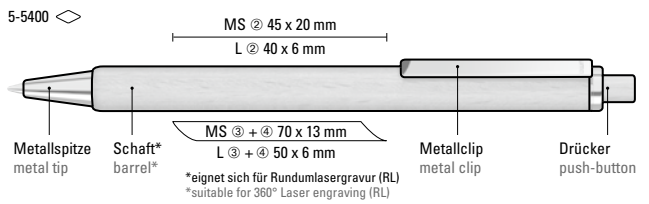

Farb-Code/Minen
Colour code/Refills

TREE
5-5400

LEAF
5-5900

5-5400 (● 8-0877)



08-W001



● 8-0877

5-5900 (● 8-0855)



37-W001



● 8-0855



Für diese uma Schreibgeräte aus Holz wird ausschließlich PEFC-zertifiziertes Buchenholz verwendet. Durch spezielle Bearbeitung des nachwachsenden Rohstoffs transportiert das Naturprodukt Ihre Werbebotschaft edel und formschön zum Kunden. Der Naturstoff Holz variiert sowohl in der Farbigkeit des Holzes, als auch in der Struktur (Maserung).

Only PEFC-certified beechwood is used for these uma writing utensils made of wood. Through special processing of the sustainable raw material, the natural product transports its advertising message in a refined and beautiful design to the customer.

Wood is a natural material with a great variety of colours and textures (grain effect).

Dank der ClimatePartner-zertifizierten Produktion leisten der uma TREE und LEAF einen zusätzlichen nachhaltigen Beitrag zur Schonung der Umwelt.

Thanks to the ClimatePartner-certified production, the uma TREE and LEAF make an additional sustainable contribution to the protection of the environment.

5-5400: Holz-Druckkugelschreiber mit Holzdrücker, Metallclip und Metallspitze glanzverchromt. Schaft und Drücker aus schutzlackiertem PEFC-zertifiziertem Buchenholz.

5-5900: Holz-Druckkugelschreiber mit Holzdrücker, Metallclip und Metallspitze glanzverchromt. Schaft und Drücker aus schutzlackiertem FSC®-zertifiziertem Buchenholz.

Preis/Stück 5-5400

1,74 €

Preis/Stück 5-5900

1,88 €

Menge

300 Stück

Werbeschlüssel

Schaft MS/L/RL



Die Modelle eignen sich für eine Lasergravur.

The models are suitable for laser engraving.

5-5400: Wooden retractable ballpoint pen with wooden push-button, metal clip and metal tip chrome plated. Barrel and push-button made from PEFC-certified beechwood with protective varnish coating.

5-5900: Wooden retractable ballpoint pen with wooden push-button, metal clip and metal tip chrome plated. Barrel and push-button made from FSC® certified beechwood with protective varnish coating.

Price/piece 5-5400

1.74 €

Price/piece 5-5900

1.88 €

Quantity

300 pieces

Advertising code

barrel MS/L/RL



Für diese uma Schreibgeräte aus Holz wird FSC®-zertifiziertes Buchenholz verwendet. Durch spezielle Bearbeitung des nachwachsenden Rohstoffs transportiert das Naturprodukt Ihre Werbebotschaft edel und formschön zum Kunden. Der Naturstoff Holz variiert sowohl in der Farbigkeit des Holzes, als auch in der Struktur (Maserung).

Only FSC® certified beechwood is used for these uma writing utensils made of wood. Through special processing of the sustainable raw material, the natural product transports its advertising message in a refined and beautiful design to the customer.

Wood is a natural material with a great variety of colours and textures (grain effect).

WOODY
5-5600

WOODY B
5-5607 B

Farb-Code/Minen
Colour code/Refills



5-5600 (● 8-0855)
5-5607 B (0,7mm)

05-W001



● 8-0855



PEFC/04-31-3311

Für diese uma Schreibgeräte aus Holz wird ausschließlich PEFC-zertifiziertes Buchenholz verwendet. Durch spezielle Bearbeitung des nachwachsenden Rohstoffs transportiert das Naturprodukt Ihre Werbebotschaft edel und formschön zum Kunden.

Der Naturstoff Holz variiert sowohl in der Farbigkeit des Holzes als auch in der Struktur (Maserung).

Only PEFC-certified beechwood is used for these uma writing utensils made of wood. Through special processing of the sustainable raw material, the natural product transports its advertising message in a refined and beautiful design to the customer.

Wood is a natural material with a great variety of colours and textures (grain effect).



ClimatePartner
zertifiziertes Produkt
climate-id.com/DIPVA4

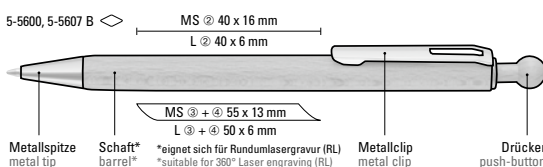

Die Modelle eignen sich für eine Lasergravur.

The models are suitable for laser engraving.

5-5600: Holz-Druckkugelschreiber mit Holz-Kugeldrücker, Metallclip und Metallspitze silber glänzend. Schaft und Drücker aus schutzlackiertem PEFC-zertifiziertem Buchenholz.

5-5607 B: Holz-Druckbleistift (0,7 mm) mit Holz-Kugeldrücker, Metallclip und Metallspitze silber glänzend. Schaft und Drücker aus schutzlackiertem PEFC-zertifiziertem Buchenholz.

5-5600: Wooden retractable ballpoint pen with wooden ball-button, metal clip and metal tip silver glossy. Barrel and push-button made from PEFC-certified beechwood with protective varnish coating.

5-5607 B: Wooden mechanical pencil (0.7 mm) with wooden ball-button, metal clip and metal tip silver glossy. Barrel and push-button made from PEFC-certified beechwood with protective varnish coating.

Preis/Stück 5-5600 2,04 €
Preis/Stück 5-5607 B 2,46 €
Menge 300 Stück
Werbeschlüssel Schaft MS/L/RL

Price/piece 5-5600 2.04 €
Price/piece 5-5607 2.46 €
Quantity 300 pieces
Advertising code barrel MS/L/RL

Farb-Code/Minen
Colour code/Refills

FOREST
5-5200

FOREST B
5-5207 B

BEECH
5-5800

5-5200 (● 8-0877)
5-5207 B (0,7mm)



05-W001



● 8-0877

5-5800 (● 8-0855)



08-W001



● 8-0855



Der Naturstoff Holz variiert sowohl in der Farbigkeit des Holzes als auch in der Struktur (Maserung).

Wood is a natural material with a great variety of colours and textures (grain effect).

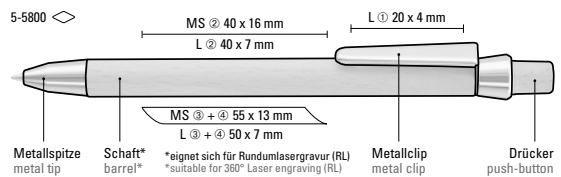
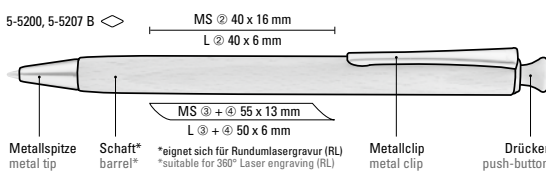

5-5200: Holz-Druckkugelschreiber mit Holzdrücker, Metallclip und Metallspitze silber glänzend. Schaft und Drücker aus schutzlackiertem PEFC-zertifiziertem Buchenholz.

5-5207 B: Holz-Druckbleistift (0,7mm) mit Holzdrücker, Metallclip und Metallspitze silber glänzend. Schaft und Drücker aus schutzlackiertem PEFC-zertifiziertem Buchenholz.

5-5800: Holz-Druckkugelschreiber mit Holzdrücker, Metallclip und Metallspitze glanzverchromt. Schaft und Drücker aus schutzlackiertem PEFC-zertifiziertem Buchenholz.

5-5200: Wooden retractable ballpoint pen with wooden push-button, metal clip and metal tip silver glossy. Barrel and push-button made from PEFC-certified beechwood with protective varnish coating.

5-5207 B: Wooden mechanical pencil (0.7 mm) with wooden push-button, metal clip and metal tip silver glossy. Barrel and push-button made from PEFC-certified beechwood with protective varnish coating.

5-5800: Wooden retractable ballpoint pen with wooden push-button, metal clip and metal tip chrome plated. Barrel and push-button made from PEFC-certified beechwood with protective varnish coating.

Preis/Stück 5-5200	1,79 €
Preis/Stück 5-5207 B	2,22 €
Menge	300 Stück
Werbeschlüssel	Schaft MS/L/RL
Preis/Stück 5-5800	2,04 €
Menge	300 Stück
Werbeschlüssel	Schaft MS/L/RL, Clip L

Price/piece 5-5200	1.79 €
Price/piece 5-5207 B	2.22 €
Quantity	300 pieces
Advertising code	barrel MS/L/RL
Price/piece 5-5800	2.04 €
Quantity	300 pieces
Advertising code	barrel MS/L/RL, clip L



Mit jedem bestellten TREECK-Schreibset wird die entsprechende Menge an Bäumen gepflanzt. Getreu dem Motto ONE ITEM – ONE IMPACT. Die beiden hochwertigen Schreibgeräte mit einem Schaft aus FSC®-zertifiziertem Walnussholz werden mit dem Logo „ONE ITEM – ONE IMPACT“ auf dem Stopfen gelasert und in der schwarzen, illustrierten Geschenkbox geliefert.

Die Welt zählt rund 3000 Milliarden Bäume. Das klingt nach einer enorm großen Zahl, in Wahrheit sind dies aber nur noch 46% aller Bestände, die es einmal gab. Pflanzen wir viele Neue und kämpfen gemeinsam gegen den Klimawandel an! Wir sind überzeugt, auch Ihre Kundschaft wird diese Aktion zu schätzen wissen!

Alles rund um ONE ITEM – ONE IMPACT auf www.uma-pen.com/TREECK

With every TREECK writing set you order, the corresponding amount of trees will be planted. True to the motto ONE ITEM – ONE IMPACT. The two high-quality writing instruments with a barrel made of FSC® certified walnut wood are laser engraved with the logo "ONE ITEM – ONE IMPACT" on the plug and delivered in the black, illustrated gift box.

The world has around 3,000 billion trees. This sounds like an enormous number, but in reality it is only 46% of the total number of trees that once existed. Let's plant lots of new ones and fight climate change together! We are convinced that your customers will also appreciate this campaign! All about ONE ITEM – ONE IMPACT at www.uma-pen.com/TREECK

Farb-Code/Minen
Colour code/Refills

TREECK-SET
ONE ITEM – ONE IMPACT

9-9370 (● 8-0888)



9-9372 R (● ● 8-0806)



Die Modelle sind mit dem „ONE ITEM – ONE IMPACT“-Logo gekennzeichnet.
The models are labelled with the “ONE ITEM – ONE IMPACT” logo.



Der Naturstoff Holz variiert sowohl in der Farbigkeit des Holzes als auch in der Struktur (Maserung).

Wood is a natural material with a great variety of colours and textures (grain effect).

9-9370: Metall-Drehkugelschreiber mit Schaft aus FSC®-zertifiziertem Walnussholz, Softdrehmechanik und gefedertem Clip. Oberteil, Clip und Spitze glanzverchromt. Stopfen mit dem „ONE ITEM – ONE IMPACT“-Logo gekennzeichnet.

9-9372 R: Metall-Rollerball mit Schaft aus FSC®-zertifiziertem Walnussholz und gefedertem Clip. Kappe und Clip glanzverchromt. Stopfen mit dem „ONE ITEM – ONE IMPACT“-Logo gekennzeichnet.

9-9370	100 Stück
Menge	Schaft MT/L, Oberteil L
Werbeschlüssel	
9-9372 R	100 Stück
Menge	Schaft MT/L, Kappe L
Werbeschlüssel	
Preis TREECK-SET	auf Anfrage

9-9370: Metal twist ballpoint pen with barrel made from FSC® certified walnut wood, soft twist mechanism and spring-mounted clip. Upper part, clip and tip glossy chrome plated. Plug is labelled with the “ONE ITEM – ONE IMPACT” logo.

9-9372 R: Metal roller ball with barrel made from FSC® certified walnut wood, spring-mounted clip. Cap and clip glossy chrome plated. Plug is labelled with the “ONE ITEM – ONE IMPACT” logo.

9-9370	100 pieces
Quantity	barrel MT/L, upper part L
Advertising code	
9-9372 R	100 pieces
Quantity	barrel MT/L, cap L
Advertising code	
Preis TREECK-SET	on request

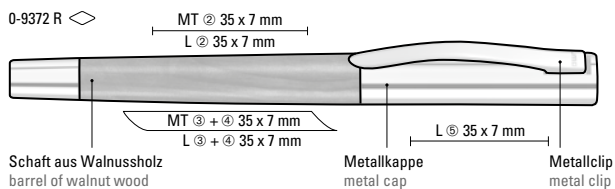
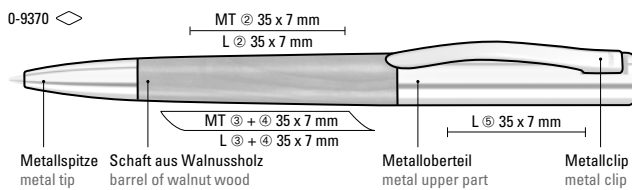

Farb-Code/Minen
Colour code/Refills

TITAN WOOD
0-9370

TITAN WOOD R
0-9372 R

0-9370 (● 8-0888)



0-9372 R (● ● 8-0806)



Für diese uma Schreibgeräte aus Holz wird FSC®-zertifiziertes Walnussholz verwendet. Durch spezielle Bearbeitung des nachwachsenden Rohstoffs transportiert das Naturprodukt Ihre Werbebotschaft edel und formschön zum Kunden. Der Naturstoff Holz variiert sowohl in der Farbigekeit des Holzes, als auch in der Struktur (Maserung).

Only FSC® certified walnut wood is used for these uma writing utensils made of wood. Through special processing of the sustainable raw material, the natural product transports its advertising message in a refined and beautiful design to the customer. Wood is a natural material with a great variety of colours and textures (grain effect).



Die Modelle eignen sich für eine Lasergravur in beige.

The models are suitable for laser engraving in beige.



Die Modelle eignen sich für eine Lasergravur.

The models are suitable for laser engraving.



Etui Empfehlung/Case suggestion

ETUI 0-0944

Informationen unter www.uma-pen.com
Information at www.uma-pen.com

0-9370: Metall-Drehkugelschreiber mit Schaft aus FSC®-zertifiziertem Walnussholz, Softdrehmechanik und gefedertem Clip. Oberteil, Clip und Spitze glanzverchromt.

0-9372 R: Metall-Rollerball mit Schaft aus FSC®-zertifiziertem Walnussholz und gefedertem Clip. Kappe und Clip glanzverchromt.

Preis/Stück 0-9370

10,00 €

Menge

100 Stück

Werbeschlüssel

Schaft MT/L, Oberteil L

Preis/Stück 0-9372 R

11,43 €

Menge

100 Stück

Werbeschlüssel

Schaft MT/L, Kappe L

0-9370: Metal twist ballpoint pen with barrel made from FSC® certified walnut wood, soft twist mechanism and spring-mounted clip. Upper part, clip and tip glossy chrome plated.

0-9372 R: Metal roller ball with barrel made from FSC® certified walnut wood, spring-mounted clip. Cap and clip glossy chrome plated.

Price/piece 0-9370

10.00 €

Quantity

100 pieces

Advertising code

barrel MT/L, upper part L

Price/piece 0-9372 R

11.43 €

Quantity

100 pieces

Advertising code

barrel MT/L, cap L



0-9190 WOOD ◊

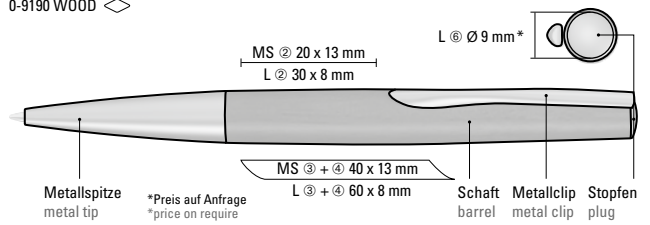

Farb-Code/Minen
Colour code/Refills

ELEGANCE WOOD
0-9190 WOOD

0-9190 WOOD (● 8-0888)



53-W001



● 8-0888



Für diese uma Schreibgeräte aus Holz wird FSC®-zertifiziertes Walnussholz verwendet. Durch spezielle Bearbeitung des nachwachsenden Rohstoffs transportiert das Naturprodukt Ihre Werbebotschaft edel und formschön zum Kunden.

Der Naturstoff Holz variiert sowohl in der Farbigkeit des Holzes, als auch in der Struktur (Maserung).

Only FSC® certified walnut wood is used for these uma writing utensils made of wood. Through special processing of the sustainable raw material, the natural product transports its advertising message in a refined and beautiful design to the customer.

Wood is a natural material with a great variety of colours and textures (grain effect).



Das Modell eignet sich für eine Lasergravur.

The model is suitable for laser engraving.

0-9190 WOOD: Metall-Drehkugelschreiber mit Schaft aus FSC®-zertifiziertem Walnussholz, gefederter Metallclip, Metallstopfen, schwere Metallspitze matt verchromt und Softdrehmechanik.

Preis/Stück
Menge
Werbeschlüssel

10,87 €
100 Stück
Schaft MS/L, Stopfen L

0-9190 WOOD: Metal twist ballpoint pen with FSC® certified walnut barrel, spring-mounted metal clip, plug, metal tip matt chrome-plated and soft twist mechanism.

Price/piece
Quantity
Advertising code

10.87 €
100 pieces
barrel MS/L, plug L



Bio-Modelle / Bio models

Cellulose / cellulose acetate



Der aus der Natur gewonnene Rohstoff kann dieser ebenfalls wieder zugeführt werden. Das Celluloseacetat entspricht der DIN EN 13432:2000-12/Zertifizierungsprogramm für Produkte aus kompostierbaren Werkstoffen. Die hierfür notwendige Cellulose wird aus europäischen Weichhölzern gewonnen.

The raw material gained from nature can also be returned to nature. The cellulose acetate complies with DIN EN 13432:2000-12/certification program for products from compostable materials. The cellulose required for this is gained from European softwoods.

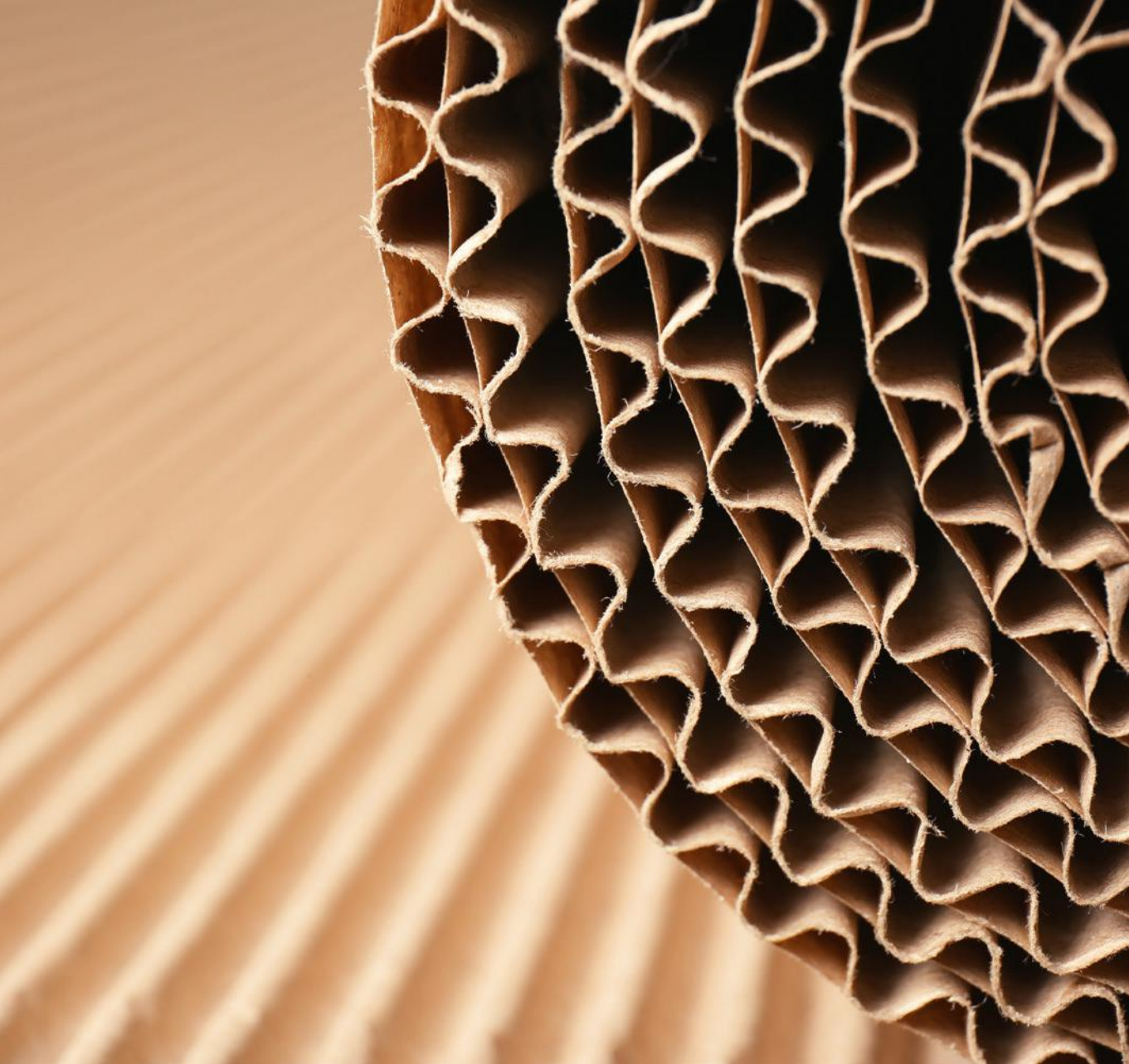

Karton-Modelle/Cardboard models

Recycelter Karton/recycled cardboard

Die Verwendung von bereits recycelter Kartonage bietet eine stabile und zugleich umweltverträgliche Grundlage für die Herstellung von Schreibgeräten. Das Material kann dem Recyclingprozess wieder zugeführt werden und trägt so zur Umweltschonung bei. Die Verwendung dieser besonderen Materialien unterliegt produktionstechnischen Schwankungen. Leichte Unterschiede in Farbe und Oberfläche sind daher möglich.

The use of cardboard that has already been recycled offers a stable and at the same time environmentally friendly basis for the production of writing utensils. The material can be returned to the recycling process again, thus contributing to helping the environment. The use of these special materials is subject to fluctuations in the production technology. As a result, slight differences in colour and surface are possible.



**Die Herstellung der Clips und der Schäfte ist aufgrund des besonderen Materials produktionstechnischen Schwankungen unterlegen. Leichte Unterschiede in der Farbe und der Oberfläche (Schlierenbildung) sind möglich.

** The production of the clips and barrels is subject to fluctuations due to the special material. Slight differences in colour and surface (smear formation) are possible.

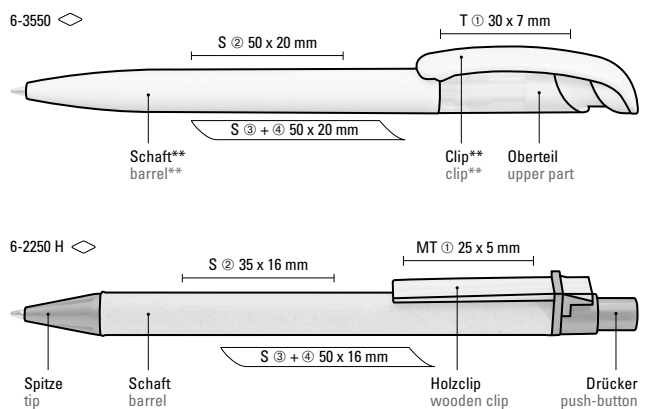

Farb-Code/Minen
Colour code/Refills

BIO PEN
6-3550

PAPER PEN
6-2250 H

6-3550 (● 8-0866)



6-2250 H (● 8-0877)



* **06-7527 BIO-MIX:** Drücker und Spitze sind aus Bio-Material gefertigt. Der Werkstoff Celluloseacetat entspricht der DIN EN 13432:2000-12 und wird aus europäischen Weichhölzern gewonnen.

* **06-7527 BIO-MIX:** Pushbutton and tip are made of bio material. This material – cellulose acetate – complies with DIN EN 13432:2000-12 and is derived from European softwoods.

6-3550: Druckkugelschreiber mit Gehäuse und Clip aus 100% nachwachsendem und kompostierbarem Material. Oberenteil aus gefrostetem ABS-Kunststoff.

6-2250 H: Druckkugelschreiber aus recycelter, naturfarbener Pappe. Spitze und Drücker unifarben aus recyceltem oder biologisch abbaubarem Kunststoff (*06-7527 Bio-Mix) sowie Holzclip.

Preis/Stück 6-3550	0,85 €
Menge	1.000 Stück
Werbeschlüssel	Schaft S ○, Clip T
Preis/Stück 6-2250 H	0,71 €
Menge	1.000 Stück
Werbeschlüssel	Schaft S, Clip MT

6-3550: Retractable ballpoint pen with barrel and clip made from 100% renewable biodegradable material. Upper part made from transparent frosted ABS plastic.

6-2250 H: Retractable ballpoint pen made from recycled, natural-coloured cardboard. Tip and push-button uni-coloured made from recycled or biodegradable plastic (*06-7527 Bio-Mix) as well as wooden clip.

Price/piece 6-3550	0.85 €
Quantity	1.000 pieces
Advertising code	barrel S ○, clip T
Price/piece 6-2250 H	0.71 €
Quantity	1.000 pieces
Advertising code	barrel S, clip MT



Metall RECY-Modelle / Metal RECY models

Das Gehäuse des STRAIGHT GUM RECY wird aus recyceltem Metall hergestellt und ist mit dem METAL-RECY-Logo gekennzeichnet.

The housing of the STRAIGHT GUM RECY is made of recycled metal and is marked with the METAL RECY logo.

STRAIGHT GUM RECY
0-9450 GUM RECY



Metall RECY – recyceltes Metall/ Metal RECY – recycled metal

Das recycelte Metall wird aus bereits vorhandenen Materialien gewonnen, was dazu beiträgt, den Verbrauch von neuen Ressourcen zu reduzieren und Abfälle zu minimieren. Durch die Verwendung von recycelten Materialien wird die Belastung der Umwelt verringert und Ressourcen geschont. Dank der ClimatePartner-zertifizierten Produktion leisten die uma Metall RECY Schreibgeräte einen zusätzlichen nachhaltigen Beitrag zur Schonung der Umwelt.

The recycled metal is obtained from existing materials, which helps to reduce the consumption of new resources and minimise waste. By using recycled materials, the impact on the environment is reduced and resources are conserved. Thanks to the ClimatePartner-certified production, the uma metal RECY writing instruments make an additional sustainable contribution to the protection of the environment.



Aluminium RECY-Modelle/Aluminium RECY models



Aluminium RECY – recyceltes Aluminium/
Aluminium RECY – recycled aluminium

Recyceltes Aluminium wird aus bereits bestehenden Aluminiumprodukten gewonnen und hilft, den Bedarf an neuen Rohstoffen zu verringern. Diese Methode reduziert sowohl den Energieverbrauch als auch den CO₂-Ausstoß, da weniger Energie für die Herstellung erforderlich ist. Dank der ClimatePartner-zertifizierten Produktion leisten die uma Aluminium RECY Schreibgeräte einen zusätzlichen Beitrag zur Schonung der Umwelt.

Recycled aluminium is obtained from existing aluminium products and helps to reduce the need for new raw materials. This method reduces both energy consumption and CO₂ emissions, as less energy is required for production. Thanks to ClimatePartner-certified production, uma aluminium RECY writing instruments make an additional sustainable contribution to the protection of the environment.



Das Gehäuse des LUMOS RECY wird aus recyceltem Aluminium hergestellt und ist mit dem rAL-Logo gekennzeichnet.

The housing of the LUMOS RECY is made of recycled metal and is marked with the rAL logo.

LUMOS RECY
0-9560 RECY



0-9450 GUM RECY, 0-9450 M GUM RECY ◊

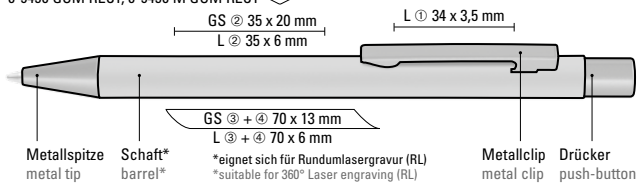

Farb-Code/Minen
Colour code/Refills

STRAIGHT GUM RECY
0-9450 GUM RECY

STRAIGHT M GUM RECY
0-9450 M GUM RECY

0-9450 GUM RECY (● 8-0855)



58-0002

0-9450 M GUM RECY (● 8-0855)



58-0002



(● 8-0855)

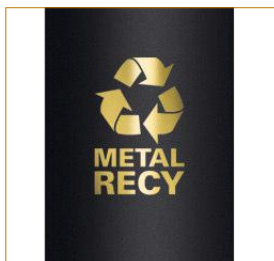

Die Modelle eignen sich für eine
Lasergravur in gold.

The models are suitable for
laser engraving in gold.



Die Modelle eignen sich für
Rundumlasergravur.

The models are suitable for 360°
laser engraving.

Das Modell ist mit dem Recyclingzeichen gekennzeichnet. Dank der ClimatePartner-zertifizierten Produktion leistet der uma STRAIGHT GUM RECY einen zusätzlichen nachhaltigen Beitrag zur Schonung der Umwelt.

The model is labelled with the recycling mark. Thanks to the ClimatePartner-certified production, the uma STRAIGHT GUM RECY makes an additional sustainable contribution to the protection of the environment.



ClimatePartner
zertifiziertes Produkt
climate-id.com/DIPVA4



0-9450 GUM RECY: Metall-Druckkugelschreiber mit Softtouch-Gehäuse aus recyceltem Metall. Metallclip, Metallspitze und Drücker GUN metallic.

0-9450 M GUM RECY: Metall-Druckkugelschreiber mit Softtouch-Gehäuse aus recyceltem Metall. Metallclip, Metallspitze und Drücker schwarz glänzend.

Preis/Stück 0-9450 GUM RECY

2,18 €

Preis/Stück 0-9450 M GUM RECY

2,18 €

Menge

300 Stück

Werbeschlüssel

Schaft GS/L/RL, Clip L

0-9450 GUM RECY: Metal retractable ballpoint pen with softtouch housing made of recycled metal. Metal clip, metal tip and push-button GUN metallic.

0-9450 M GUM RECY: Metal retractable ballpoint pen with softtouch housing made of recycled metal. Metal clip, metal tip and push-button glossy black.

Price/piece 0-9450 GUM RECY

2.18 €

Price/piece 0-9450 M GUM RECY

2.18 €

Quantity

300 pieces

Advertising code

barrel GS/L/RL, clip L



0-9530 RECY, 0-9530 M RECY ◊

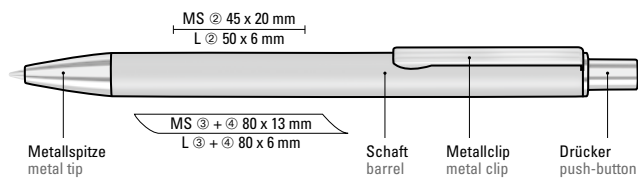

0-9530 TO RECY ◊

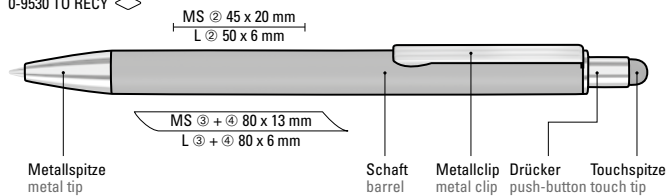

Farb-Code/Minen
Colour code/Refills

GROOVE RECY
0-9530 RECY **new!**

GROOVE M RECY
0-9530 M RECY **new!**

GROOVE TO RECY
0-9530 TO RECY **new!**

0-9530 RECY (● 8-0855)
0-9530 TO RECY (● 8-0855)



0-9530 M RECY (● 8-0855)



Die Modelle eignen sich für eine Lasergravur in weiß.

The models are suitable for laser engraving in white.

Das Modell ist mit dem Recyclingzeichen gekennzeichnet. Dank der ClimatePartner-zertifizierten Produktion leistet der uma GROOVE RECY einen zusätzlichen nachhaltigen Beitrag zur Schonung der Umwelt.

The model is labelled with the recycling mark. Thanks to the ClimatePartner-certified production, the uma GROOVE RECY makes an additional sustainable contribution to the protection of the environment.



0-9530 RECY: Metall-Druckkugelschreiber mit matter Oberfläche aus recyceltem Aluminium. Metallclip mit eingelassenen Rillen, Metallspitze und Drücker in silber glänzend.

0-9530 M RECY: Metall-Druckkugelschreiber mit matter Oberfläche aus recyceltem Aluminium. Metallclip mit eingelassenen Rillen, Metallspitze und Drücker in schwarz matt.

0-9530 TO RECY: Metall-Druckkugelschreiber mit matter Oberfläche aus recyceltem Aluminium. Metallclip mit eingelassenen Rillen, Metallspitze in silber glänzend und Drücker mit integrierter Touchscreensteuerung.

Preis/Stück 0-9530 RECY	1,28 €
Preis/Stück 0-9530 M RECY	1,28 €
Preis/Stück 0-9530 TO RECY	1,42 €
Menge	300 Stück
Werbeschlüssel	Schaft MS/L

0-9530 RECY: Metal retractable ballpoint pen with matt finish made from recycled aluminium. Metal clip with recessed grooves, metal tip and push-button in glossy silver.

0-9530 M RECY: Metal retractable ballpoint pen with matt finish made from recycled aluminium. Metal clip with recessed grooves, metal tip and push-button in matt black.

0-9530 TO RECY: Metal retractable ballpoint pen with matt finish made from recycled aluminium. Metal clip with recessed grooves, metal tip in glossy silver and push-button with integrated touch screen control.

Price/piece 0-9530 RECY	1.28 €
Price/piece 0-9530 M RECY	1.28 €
Price/piece 0-9530 TO RECY	1.42 €
Quantity	300 pieces
Advertising code	barrel MS/L



0-9560 RECY ◊

MS ② 35 x 20 mm
L ② 35 x 7 mm

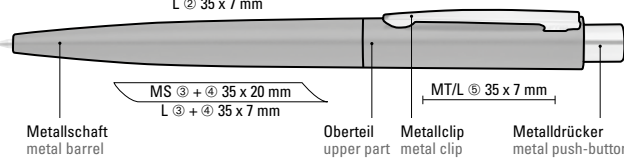

Farb-Code/Minen
Colour code/Refills

LUMOS RECY
0-9560 RECY **new!**

0-9560 RECY (● 8-0855)



Die Modelle eignen sich für eine
Lasergravur in weiß.

The models are suitable for laser
engraving in white.

Das Modell ist mit dem Recyclingzeichen gekennzeichnet. Dank
der ClimatePartner-zertifizierten Produktion leistet der uma
LUMOS RECY einen zusätzlichen nachhaltigen Beitrag zur
Schonung der Umwelt.

The model is labelled with the recycling mark. Thanks to the
ClimatePartner-certified production, the uma LUMOS RECY
makes an additional sustainable contribution to the protection of
the environment.



ClimatePartner
zertifiziertes Produkt
climate-id.com/DIPVA4



0-9560 RECY: Metall-Druckkugelschreiber mit matt lackiertem
Gehäuse aus recyceltem Aluminium. Metallclip und Drücker
glanzverchromt.

Preis/Stück
Menge
Werbeschlüssel

1,39 €
300 Stück
Schaft MS/L, Oberteil MT/L

0-9560 RECY: Metal retractable ballpoint pen with matt
lacquered housing made from recycled aluminium. Metal clip and
push-button chrome plated.

Price/piece
Quantity
Advertising code



1.39 €
300 pieces
barrel MS/L, upper part MT/L

ck-in:
- 22.00
ck-out:
- 11.00



Farb-Code/Minen
Colour code/Refills

RECYCLED PET BOX
0-2225 **new!**

- 57-2143 
- 57-CG11 
- 57-4268 



Unterseite: geprägtes Logo
(alle Farben)
Bottom part: embossed logo
(all colours)



Deckel: geprägtes rPET-Logo
(blau und grau)
Lid: embossed rPET-logo
(blue and grey)



Deckel: geprägtes "Social
Plastic"-Logo (nur sandfarben)
Lid: embossed "Social Plastic"-
logo (sand only)



0-2225 

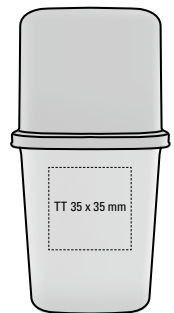

Aufgrund der Besonderheiten des Materials
(recyceltes PET-Material) sind produktions-
technische Farbschwankungen gegeben.

Due to the special nature of the material
(recycled PET material) production-related
variations are possible.

Das aus recycelten PET-Flaschen in Europa hergestellte
rPET-Material eignet sich für einen langlebigen und nachhaltigen
Werbeinsatz. Dank der europäischen und ClimatePartner-
zertifizierten Produktion leistet die uma RECYCLED PET BOX
einen zusätzlichen nachhaltigen Beitrag zur Schonung der
Umwelt.

The rPET material, which is produced in Europe from recycled
PET bottles, is suitable for a durable and sustainable
advertisement. Thanks to the European and ClimatePartner-
certified production, the uma RECYCLED PET BOX makes an
additional sustainable contribution to the protection of the
environment.



0-2225: Verpackungs- und Präsentationsbox aus recyceltem
PET-Material. Kann als POS-Aufsteller eingesetzt werden.

Preis/Stück 2,14 €
Menge 100 Stück
Werbeschlüssel TT

0-2225: Packaging and presentation box made from recycled PET
material. Can be used as a POS display.

Price/piece 2.14 €
Quantity 100 pieces
Advertising code TT

PAPPSTECKETUI RECY
 CARDBOARD SLIP-IN CASE RECY
 0-0940 RECY



ETUI rPET
 0-0955 rPET



0-0940 RECY ◊

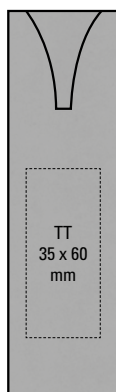

0-0955 rPET ◊



0-0940 RECY: Pappstecketui aus FSC®-zertifiziertem Naturkarton für ein Schreibgerät, mit aufgedrucktem Recycling Hinweis auf der Rückseite. Farbschwankungen aufgrund des Recyclingprozesses gegeben.

0-0955 rPET: Etui aus recyceltem PET Material für ein oder zwei Schreibgeräte.

Preis/Stück 0-0940 RECY	0,33 €
Menge	100 Stück
Werbeschlüssel	TT
Preis/Stück 0-0955 rPET	0,66 €
Menge	100 Stück
Werbeschlüssel	HD

0-0940 RECY: Natural cardboard case made of FSC® certified cardboard for one writing instrument, with printed recycling information on the back. Colour variations may occur due to the recycling process.

0-0955 rPET: Case made of recycled rPET material for one or two writing instruments.

Price/piece 0-0940 RECY	0.33 €
Quantity	100 pieces
Advertising code	TT
Price/piece 0-0955 rPET	0.66 €
Quantity	100 pieces
Advertising code	HD

Unterverpackung

Für die Verpackung der Schreibgeräte verwenden wir ausschließlich Polybeutel aus 80 % recyceltem Material. Dies entspricht aktuell dem Maximalwert an recyceltem Material in Polybeuteln. Die Beutel können zu 100 % wieder dem Recycling Prozess zugeführt werden.

Wir weisen ausdrücklich darauf hin, dass wir bewusst auf den Einsatz von biologisch abbaubaren Materialien in den Polybeuteln verzichten. Diese Materialien können dem Recycling Prozess nicht zugeführt werden. Zudem stehen industrielle Kompostieranlagen bzw. Entsorgungsströme nicht zur Verfügung.

Zum Schutz der Schreibgeräte beim Transport und zur Vermeidung von voluminösem Kartonagenmüll empfehlen wir die Verpackung der Produkte in der uma LDPE-Bag.



Reduced amounts of packaging

We only use polythene bags made of 80 % recycled material to pack our writing instruments. This currently equates to a maximum value of recycled material in polythene bags. 100 % of these bags can be returned to the recycling process.

We specifically wish to advise that we deliberately avoid the use of bio-degradable materials in these polythene bags. These materials cannot be directed to the recycling process. Furthermore, industrial composting facilities and/or formal disposal mechanisms are not available.

To protect our writing instruments during transport, and to avoid high volumes of packaging waste, we recommend packing these products in an uma LDPE bag.



Umverpackung

Die für den Transport verwendeten Umverpackungen der uma Produkte erfolgt in Kartons, die zu mehr als 85 % aus Altpapier bestehen und zertifiziert sind.



Surrounding packaging

The cartons we use for the transport of the uma products comprise more than 85 % of used(old) paper and are certified.

Versand

Auf Wunsch liefern wir Ihnen gerne die bestellte Ware ClimatePartner-zertifiziert. Gemeinsam mit UPS Carbon wird die CO₂-Emission berechnet und in renommierten Klimaschutzprojekten ausgeglichen.

Shipping

As an option, we would also be pleased to use ClimatePartner-certified packaging for the goods we send to you. Together with UPS Carbon, the CO₂ emission is calculated, and then balanced out in reputable climate protection projects.



Die Handschrift der Werbung



1301



Sägstraße 6, 82549 Königsdorf
08179/94799-0

info@lerche-werbemittel.de
www.lerche-werbemittel.de